

THE ORIGIN OF PLEOCHROISM IN ERYTHRITE

G. H. FAYE* AND E. H. NICKEL†

ABSTRACT

Optical absorption measurements show that the pleochroism of erythrite is due to variations in the main absorption envelope in the 400 to 600-m μ region as crystallographically oriented sections are rotated in linearly polarized light. The absorption envelope arises from the ${}^4T_1(F) \rightarrow {}^4T_1(P)$ transition, with contributions from transitions derived from 2G and 2H levels, in octahedrally coordinated Co^{2+} ions, of which there are two kinds (Co_I and Co_{II}) in erythrite. The pleochroism is related to the interaction of the electric vector of light with electrons located in specific t_{2g} orbital lobes of ions in the Co_I and Co_{II} sites.

The validity of the present interpretation rests on the assumptions that erythrite is isostructural with vivianite and symplecite and that the principal optical directions are essentially coincident with the "molecular axes" of the Co^{2+} -bearing octahedra.

INTRODUCTION

In a recent study of the polarized optical absorption spectrum of vivianite (Faye *et al.* 1968), it was proposed that the intense visible pleochroism of partially oxidized vivianite was due to $\text{Fe}^{2+} \rightarrow \text{Fe}^{3+}$ electronic interaction between adjacent iron ions that share an octahedral edge and straddle the a -crystallographic axis, i.e. ions in the Fe_{II} sites (Mori & Ito, 1950).

Erythrite ($\text{Co}_3(\text{AsO}_4)_2 \cdot 8\text{H}_2\text{O}$) is known to be similar crystallographically to vivianite ($\text{Fe}_3(\text{PO}_4)_2 \cdot 8\text{H}_2\text{O}$) and symplecite ($\text{Fe}_3(\text{AsO}_4)_2 \cdot 8\text{H}_2\text{O}$) (Barth 1937), and to exhibit moderately intense optical pleochroism. However, it was thought unlikely that its pleochroism could be interpreted in a similar manner to that of vivianite, i.e. by analogy, mainly due to the interaction of Co^{2+} and Co^{3+} ions. Since a good specimen of erythrite was available, an opportunity was provided to study its polarized absorption spectra with the object of explaining its pleochroism.

EXPERIMENTAL

Erythrite sample

The specimen of erythrite, the locality of which was Bou-Azer, Morocco, was obtained from Mr. H. R. Steacy, curator of the reference series of the National Mineral Collection, Geological Survey of Canada. Partial chemical analyses of this material are given in Table I.

*Research Scientist, Inorganic Chemistry Subdivision †Head, Mineralogy Section, Mineral Sciences Division, Mines Branch, Department of Energy, Mines and Resources, 555 Booth St., Ottawa, Canada.

TABLE 1. ERYTHRITE: CHEMICAL ANALYSIS
(Analyst: J. C. Hole)

	%	Molarity*
Cobalt	25.5	13
Iron	0.50	~0.3
Nickel	0.55	~0.3

*Molarity calculated on the basis of an assumed density of 3g/ml.

Experimental technique and apparatus

Erythrite has perfect 010 cleavage, and the *Y* and *Z* vibration directions lie in the cleavage plane; consequently, polarized spectra parallel to the *Y* and *Z* vibration directions are readily obtained. To obtain the *X* spectrum, however, it was necessary to prepare oriented sections perpendicular to the cleavage plane; this was done as follows: The principal vibration directions in a cleavage plate were identified from the optical interference figure obtained under a petrographic microscope. The cleavage plate was then mounted in a cold-setting resin, and cut with a wire saw. Sections were cut perpendicular to the cleavage, one parallel to the *Y* vibration direction, and one parallel to *Z*. The resulting *X-Y* and *X-Z* sections were then mounted on glass slides and ground to a thickness appropriate to the measurement procedure. Thicknesses were measured by the Duc de Chaulnes' method, i.e., using the fine focussing adjustment on the microscope; measurements were made through the mounting resin immediately adjacent to the erythrite, and corrected for refractive index of the resin.

All spectra were obtained at room temperature with a Cary 14 recording spectrophotometer.

The light was polarized by placing a Polaroid film, the vibration direction of which was known, in both the sample and reference beams. The vibration direction of the polarized light, symbolized by $E_{//}$ or E_{\perp} to a specific optical direction, is marked on the spectra in the figures of this paper. Because Polaroid film is not effective as a polarizer at wavelengths greater than ~ 800 m μ , matched Nicol prisms were used to measure the spectra of Fig. 5 in the infrared region.

Extinction coefficients were calculated from the expression $\epsilon = A/C \times l$, where A is the absorbance at band maximum, C is the Co^{2+} concentration in moles/litre (13M) and l is the thickness in cm.

Most spectra were analyzed using a Dupont Model 310 curve analyzer to determine the Gaussian contribution of the major components to the absorption envelopes. These appear as dashed curves in the appropriate figures.

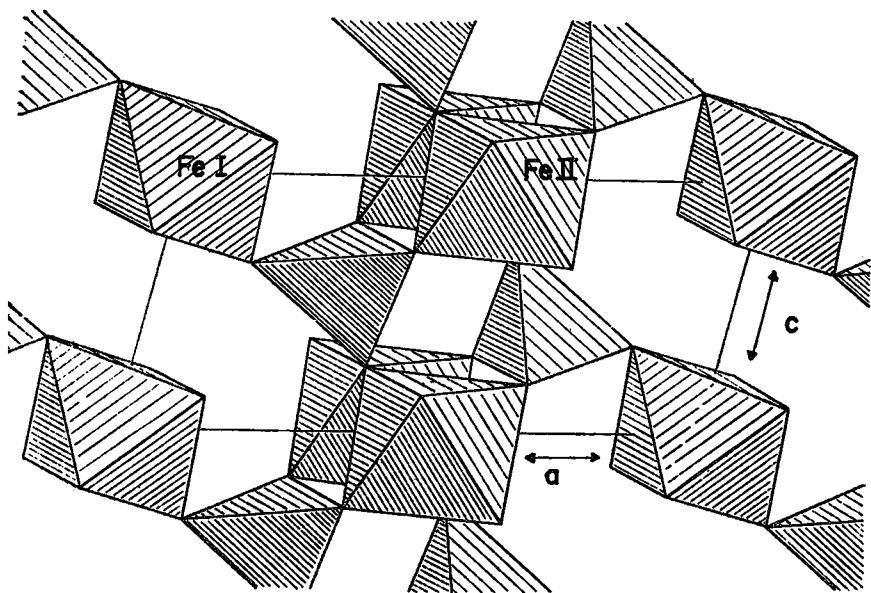

FIG. 1. Diagrammatic representation of coordination of an $a - c$ cleavage tablet of vivianite showing the Fe_I and Fe_{II} sites (after Mori & Ito, 1950).

THE STRUCTURE OF ERYTHRITE

Erythrite $\text{Co}_3(\text{AsO}_4)_2 \cdot 8\text{H}_2\text{O}$ belongs to the group of minerals whose chemical composition is expressed by the formula $M_3(\text{XO}_4)_2 \cdot 8\text{H}_2\text{O}$, where $M = \text{Fe}, \text{Co}, \text{Ni}, \text{Zn}, \text{Cr}, \text{Mg}$ and X is P or As.

The structures of vivianite ($\text{Fe}_3(\text{PO}_4)_2 \cdot 8\text{H}_2\text{O}$) and symplectite ($\text{Fe}_3(\text{AsO}_4)_2 \cdot 8\text{H}_2\text{O}$) have been determined (Mori & Ito, 1950), and the general structure type is depicted in Fig. 1.

It is reasonable, and necessary for the present work, to assume that erythrite is isostructural with vivianite and symplectite. The assumption is supported by their having the same space group ($C2/m$), by a consideration of their unit-cell dimensions, which are given below, and also by the close similarity of their x -ray powder diffraction patterns.

	a	b	c	β
Vivianite (Mori & Ito)	10.08	13.43	4.70	104°30'
Symplectite (Mori & Ito)	10.25	13.48	4.71	103°50'
Erythrite (Barth, 1937)	10.18	13.34	4.73	105°01'

It is important to note that Fe^{2+} , and presumably Co^{2+} , are in nearly regular octahedral sites judging from the bond distances and angles reported by Mori & Ito.

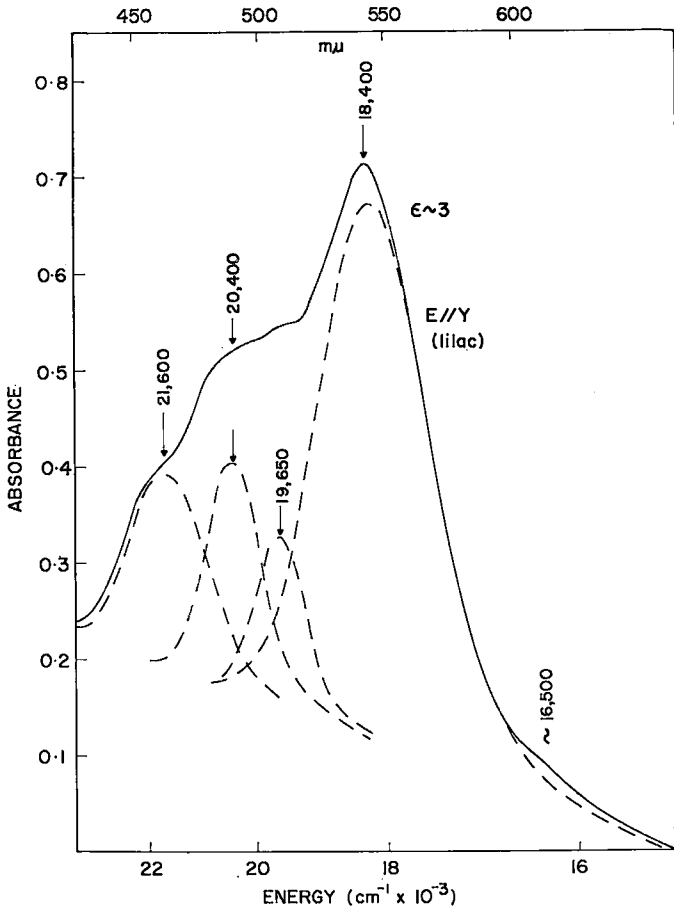

FIG. 2. $E//Y$ spectrum of an $X - Y$ section of erythrite; thickness 0.015 cm.

OPTICAL ABSORPTION SPECTRA

The polarized absorption spectra of oriented sections

Figures 2, 3, and 4 show $E//Y$, $E//Z$ and $E//X$ spectra, in the visible region, of sections containing the $X-Y$, $Y-Z$ and $X-Z$ optical directions, respectively. Although they are not shown, the $E//X$ spectrum of the $X-Y$ section, the $E//Y$ spectrum of $Y-Z$ section, and the $E//Z$ spectrum of the $X-Z$ sections are essentially the same as their counterparts in Figs. 2-4.

From Figs 2-4 it is apparent that each spectrum has three features in common: a principal absorption band centred at $18,400 \text{ cm}^{-1}$ or

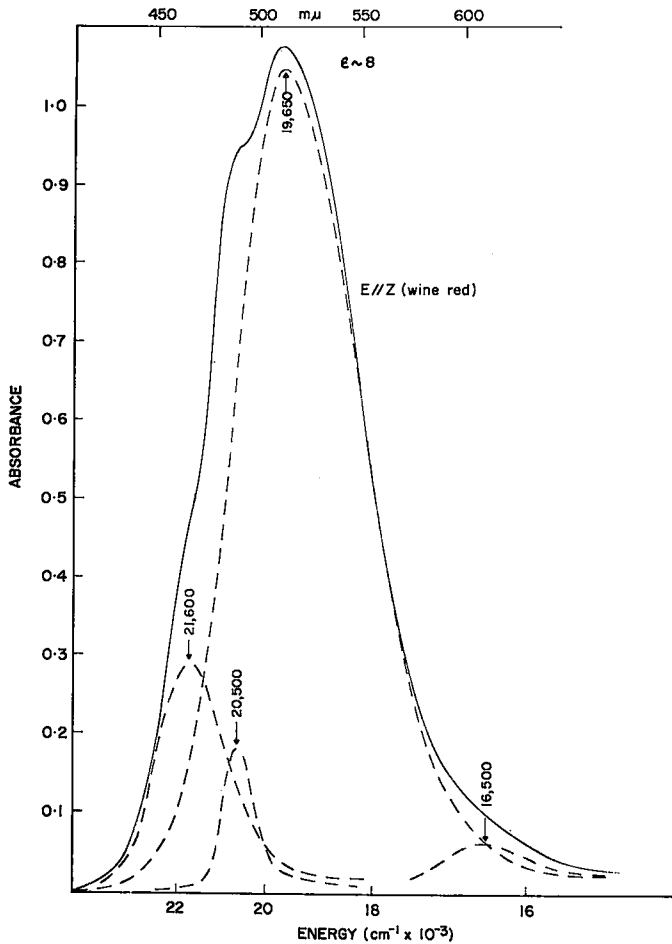

FIG. 3. $E//Z$ spectrum of a $Y-Z$ section of erythrite; thickness 0.01 cm.

$\sim 19,600 \text{ cm}^{-1}$ and two minor bands, one at $20,400\text{--}20,500 \text{ cm}^{-1}$ and the second at $21,400\text{--}21,600 \text{ cm}^{-1}$. The visible (400 to $700\text{-m}\mu$) pleochroism of erythrite is related to subtle changes in energy and intensity of these three bands as the direction of vibration incident polarized light is changed from one optical direction to another.

The wine-red colour associated with the $E//Z$ spectrum of the $X-Z$ and $Y-Z$ sections is due to the absorption of blue-green light between 450 and $550 \text{ m}\mu$; alternatively, the colour may be regarded as the combined effect of the transmission of violet to blue light in the 400 to $450\text{-m}\mu$ region and of yellow to orange light in the 550 to $700\text{-m}\mu$ region.

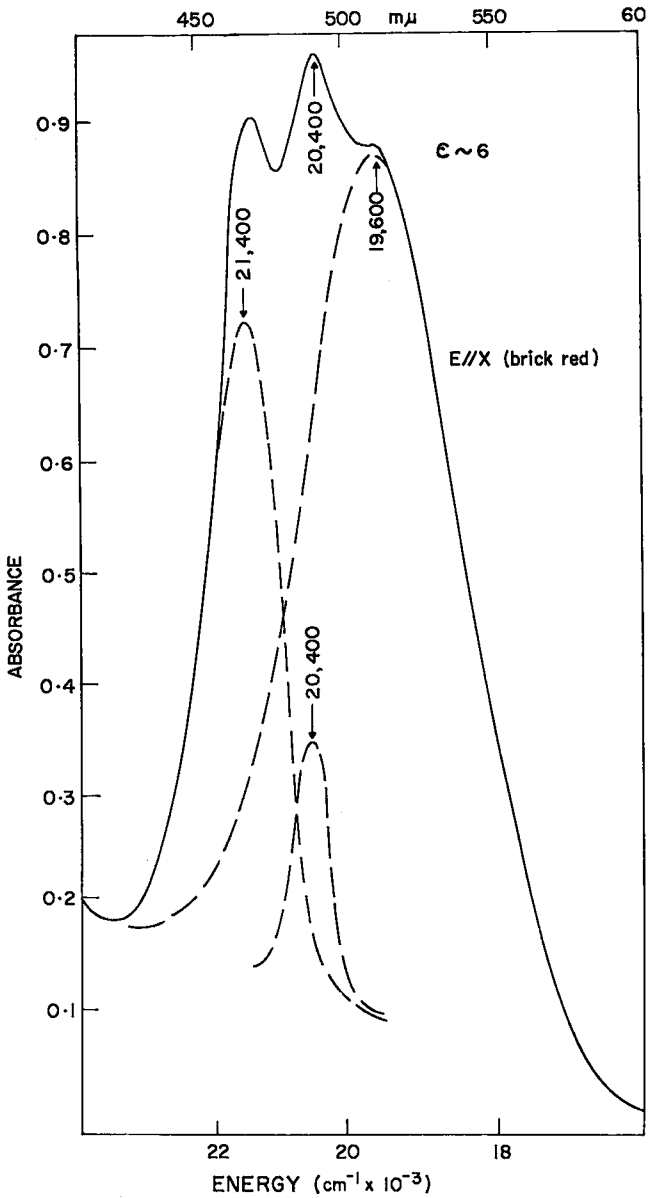

FIG. 4. $E//X$ spectrum of an $X-Z$ section of erythrite; thickness 0.01 cm.

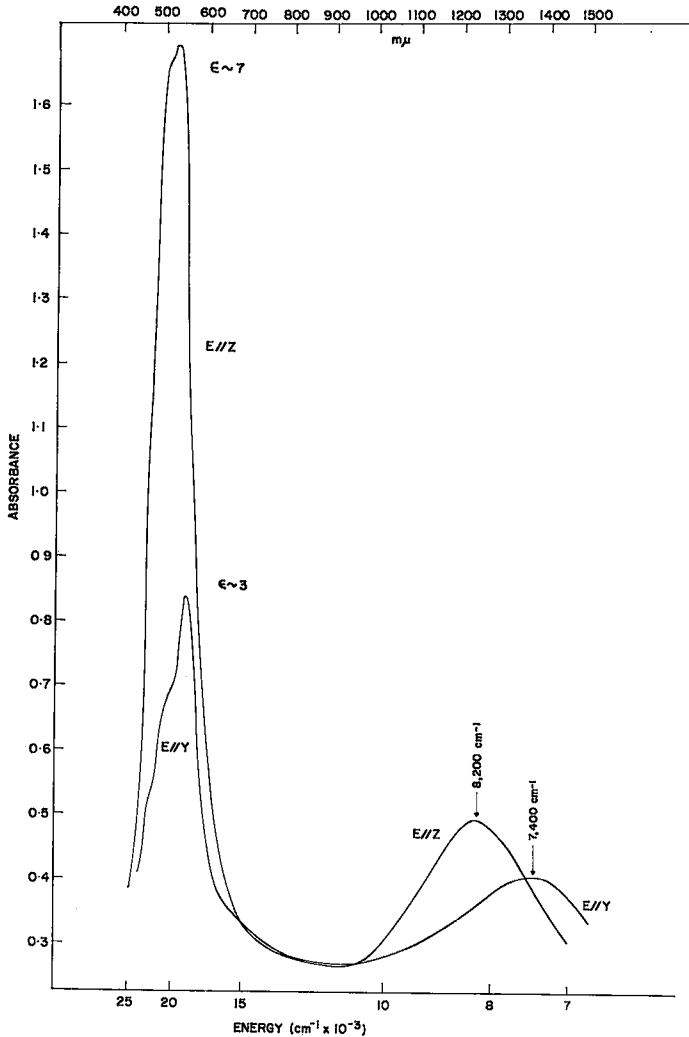

FIG. 5. $E//X$ and $E//Y$ spectra of an $a - c$ cleavage tablet of erythrite; thickness 0.018 cm.

The absorption envelope of the $E//Y$ spectrum of $X-Y$ and $Y-Z$ sections is shifted to a somewhat longer wavelength (because of the $18,400\text{-cm}^{-1}$ band) relative to that of the $E//Z$ spectrum, i.e. a purple component is added to the red, thus resulting in the lilac color of the sections.

Similarly the brick-red colour associated with the $E//X$ spectrum of $X-Y$ and $X-Z$ sections is due to an orange component added to the red

as the absorption envelope is broadened to include the blue part of the spectrum on the short wavelength side. This broadening is due to the enhanced intensity of the $21,400\text{-cm}^{-1}$ band relative to that in the $E//Y$ and $E//Z$ spectra.

Although the foregoing account describes the nature of the spectral changes that result in the pleochroism of erythrite, it now remains to explain their origin.

Interpretation of spectra

Because Co^{2+} in erythrite is octahedrally coordinated, it is logical to attempt to interpret its spectra in terms of $d-d$ electronic transitions that may be induced when the ion is located in an octahedral crystal or ligand field. Indeed, the spectra of Figs. 2-5 are qualitatively similar to those of many other materials whose spectra have been explained on the basis of electronic transitions within the $3d$ sub-shell of Co^{2+} in an octahedral environment (e.g. Pappalardo, 1959; Ferguson *et al.*, 1963; Lever & Ogden, 1967).

Throughout the rest of this paper it will be assumed that the reader has a knowledge of elementary crystal- or ligand-field theory and is familiar with the spectroscopic notations associated with it.

For Co^{2+} in a weak to moderate crystal field of O_h symmetry, there are spin-allowed transitions from the quadruplet ground state to quadruplet excited states; these are designated in order of increasing energy, as follows:

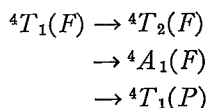

It is well established that ${}^4T_1 \rightarrow {}^4T_2$ transition gives rise to a band system in the near infrared region of Co^{2+} spectra; consequently the bands at approximately 8200 cm^{-1} and 7400 cm^{-1} in the spectra of Fig. 5 may be assigned with confidence to this transition.

Similarly, it is known that the absorption envelope found in the visible region of octahedral Co^{2+} spectra, i.e. the envelope responsible for pleochroism in erythrite, is due to a combination of the spin-allowed ${}^4T_1 \rightarrow {}^4T_1$ transition (which may include narrowly split components due to spin-orbit coupling) and weaker spin-forbidden transitions to states arising from 2H and 2G free-ion terms (Ferguson *et al.* 1963; Lever & Ogden 1967).

It is reasonable then to assign, at least tentatively, both the $18,400\text{-cm}^{-1}$ band of the $E//Y$ spectra and the $19,600\text{-cm}^{-1}$ band of the $E//X$ and $E//Z$ spectra to the ${}^4T_1 \rightarrow {}^4T_1$ transition even though the band maxima differ appreciably in energy. Also, the bands on the high-energy (i.e., short wavelength) side of the absorption envelope in these spectra can

be ascribed to the spin-forbidden transitions. The weak appearance of the 19,650-cm⁻¹ band in the $E//Y$ spectrum of Fig. 2 is considered to be due to imperfect orientation of the erythrite and can be thought of as a "remnant" of the band of corresponding energy in $E//X$ spectrum.

The ${}^4T_1 \rightarrow {}^4A_2$ transition is a "two electron" transition (i.e. ${}^5t_{2g} {}^2e_g \rightarrow {}^3t_{2g} {}^4e_g$) (Ballhausen 1962), and usually results in a very weak band that is often obscured. However, this weak feature has been located on the low-energy side of the main absorption band in the spectra of a number of materials containing pseudo-octahedrally coordinated Co²⁺ (Ferguson *et al.* 1963; Lever & Ogden 1967; Faye and Horwood 1967).

A low-intensity shoulder appears at approximately 16,500 cm⁻¹ in $E//Y$ and $E//Z$ spectra in Figs. 2 and 3 respectively; this shoulder can then be assigned to the ${}^4T_1 \rightarrow {}^4A_2$ transition.

Correlation of spectra and structure

Assuming that erythrite is isostructural with vivianite and symplectite, then the orientation of the cobalt-oxygen octahedra of erythrite should be similar to that shown in Fig. 1 for the iron-oxygen octahedra in vivianite and symplectite. Part of this structure is shown re-drawn in Fig. 6, with the addition of the Cartesian "molecular axes" for each of the two kinds of cobalt sites, and of those d -orbital lobes that lie in, and normal to, the a - c crystallographic plane (i.e., those lobes that lie in the optical symmetry planes). Orbital lobes not lying in the optical symmetry planes have not been shown, since they are not regarded to be of significance in the interpretation of the spectra. The orientation of the octahedra has been changed somewhat from that shown in Fig. 1, so that the orbital lobes coincide with the principal vibration directions of erythrite.

The orientation of the principal optical vibration directions of vivianite (Winchell, 1951) with respect to the crystallographic directions (Mori & Ito, 1950) is such that the Y optical vibration direction is fairly close (between 5° and 9°) to the xy "molecular plane" of the Fe_I octahedra and the z -axis of the Fe_{II} octahedra. Similarly, the Z optical vibration direction is close (between 4° and 7°) to the z -axis of the Fe_I octahedra and to the xy plane of the Fe_{II} octahedra. Considering the fact that the structures of vivianite and symplectite were based on estimated diffraction intensities (Mori & Ito 1950), and have not been subsequently refined, the correspondence between optical and structural differences is fairly good. Similar agreement can be expected between the optical directions of erythrite and the "molecular axes" of the Co_I and Co_{II} octahedra. Throughout the rest of this paper it will be assumed that these directions coincide.

It is known that the absorption spectrum of Co²⁺ in an octahedral environment arises through excitation of one or more electrons from t_{2g} orbitals to e_g orbitals. From a consideration of the orientations of the

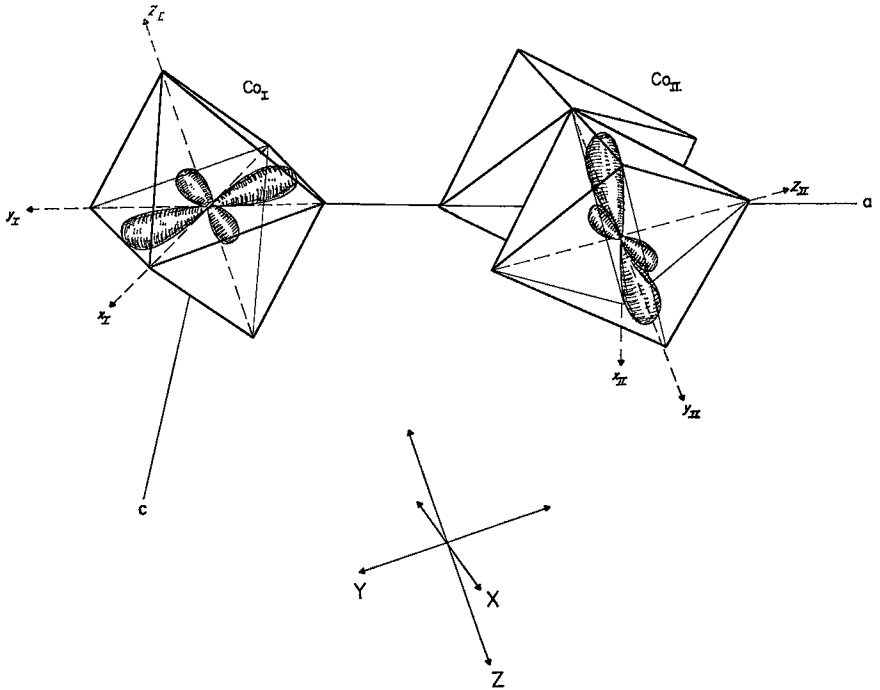

FIG. 6. The assumed orientation of cobalt-bearing octahedra of erythrite. The shaded regions represent the d -orbital lobes that interact with polarized light.

12 lobes of the three t_{2g} orbitals (d_{xy} , d_{xz} , d_{yz}) it is readily apparent from Fig. 6 that two lobes of the d_{xy} orbital of the Co_I ion are coincident with Y and the other two lobes are coincident with X . Similarly, two lobes of the d_{xy} orbital of the Co_{II} ion are also coincident with X while the other two are coincident with Z . Thus, a facile explanation for the $E \parallel X$, $E \parallel Y$ and $E \parallel Z$ spectra of Figs. 2-4 is suggested by considering how the electric vector of incident polarized light interacts with the specific lobes of the d_{xy} orbitals of the Co_I and Co_{II} ions as the vibration direction varies from one principal optical direction to another.

Since only the Co_I ion has d -orbital lobes suitably oriented for interaction with the electric vector (E) in the Y -direction, it is reasonable to conclude that the $E \parallel Y$ spectrum is due to the Co_I ion alone. Conversely, when E is in the Z direction, only the Co_{II} ions have d -orbital lobes in this direction, thereby providing the opportunity for the interaction resulting in the $E \parallel Z$ spectrum. This argument is strengthened by noting that the ϵ value for the 19,650- cm^{-1} band of the $E \parallel Z$ spectrum is some 2-3 times larger than that for the corresponding 18,400- cm^{-1} band in the $E \parallel Y$ spectrum; this is consistent with the fact that there are two Co_{II} ions for every Co_I ion in erythrite.

From Fig. 6 it can be seen that in the X direction both the Co_I and Co_{II} ions have orbital lobes that are suitably oriented for maximum interaction with E . From previous arguments then it might be expected that the $E//X$ spectrum would show both the $18,400\text{-cm}^{-1}$ band due to the Co_I ion and the $19,600\text{-cm}^{-1}$ band due to the Co_{II} ion; however, only the latter feature is found in the spectrum. The absence of the $18,400\text{-cm}^{-1}$ band may be related to the fact that one t_{2g} orbital of the Co^{2+} ion in the ground state (${}^5t_{2g}^2e_g$) is singly occupied, (i.e. having only one electron), and in Co_I this may be the d_{xy} orbital. Certainly, if the two lobes of this orbital which lie in the X direction are essentially void and the two lobes in the Y direction contain the electron, then the $18,400\text{-cm}^{-1}$ band will appear only in the $E//Y$ spectrum. If the d_{xy} orbital of Co_I is singly occupied then it is the least stable of the three t_{2g} orbitals; however, it is not obvious why this should be so. Also, it leaves unanswered the question of why the lobes pointing in the Y direction should be preferentially occupied by the lone electron. Despite these uncertainties, however, the available evidence seems to favour the above interpretation.

The $19,600\text{-cm}^{-1}$ band associated with the Co_{II} ion is present in both the $E//Z$ and $E//X$ spectra. This certainly indicates that all four lobes of the d_{xy} orbital interact with the electric vector of the incident light.

It is concluded, therefore, that the $E//X$ spectrum is due to Co_{II} ions only.

Although the pleochroism of erythrite has been related mainly to the polarization properties of the ${}^4T_1(F) \rightarrow {}^4T_1(P)$ transition of the Co_I and Co_{II} ions at $18,400\text{ cm}^{-1}$ and $19,600\text{ cm}^{-1}$ respectively, it remains to explain the difference in energy of these transitions.

Figure 5 shows the complete $d-d$ spectra of a $Y-Z$ (cleavage tablet) of erythrite. It is evident that the band system in the near infrared region, which was previously assigned to the ${}^4T_1(F) \rightarrow {}^4T_1(F)$ transition, has the same pleochroic or polarization properties as the bands due to the ${}^4T_1(F) \rightarrow {}^4T_1(P)$ transition. That the $8,200\text{ cm}^{-1}$ -band in the $E//Z$ spectrum is nearly twice as intense and at somewhat higher energy than $7,400\text{ cm}^{-1}$ -band of the $E//Y$ spectrum, strongly suggests that the former is due to the Co_{II} ions and the latter to Co_I ions. Because both the ${}^4T_1(F) \rightarrow {}^4T_1(F)$ and ${}^4T_1(F) \rightarrow {}^4T_2(P)$ transitions are at significantly higher energies for the Co_{II} ion ($8,200\text{ cm}^{-1}$ and $19,600\text{ cm}^{-1}$ respectively) than for the Co_I ion ($7,400\text{ cm}^{-1}$ and $18,400\text{ cm}^{-1}$ respectively), it is reasonable to suggest that the strength of the crystal field is somewhat different for each kind of ion. These energy differences might also be accounted for, in part, by differences in the Racah parameter, B , for the two kinds of Co^{2+} ions.

The two relatively low-intensity bands on the high-energy side of the

absorption envelope of the spectra in Figs. 2-4 have been mentioned previously. It is considered unlikely that they are due to "foreign" transition-metal ions or, because of previous arguments, to low-symmetry components of the crystal field. Also on the basis of their large energy separation from the main band at 19,600 cm^{-1} or 18,400 cm^{-1} these features are probably not due to spin-orbit coupling (Ferguson *et al.* 1963). It is reasonable, then, to assign the 20,400 to 20,500- cm^{-1} and the 21,400 to 21,600- cm^{-1} bands to quadruplet \rightarrow doublet transitions. States arising from the 2H and 2G free-ion terms are known to be at energies somewhat higher than the ${}^4T_1(P)$ level (Pappalardo 1959, Ferguson *et al.* 1963; Lever & Ogden 1967). Because of the relative constancy of the energy and intensity of the 20,400 cm^{-1} band it is tentatively assigned to a field-independent component of 2G .

The remaining band may contain one or more components derived from the 2H level. It is of interest to note again that the 21,400- cm^{-1} band is sufficiently intense in the $E//X$ spectrum (Fig. 4) to significantly influence the color of the erythrite section.

ACKNOWLEDGMENT

The authors wish to thank Dr. P. G. Manning for the suggestion that the d_{xy} orbital of the Co_I ion of erythrite may contain a single electron.

REFERENCES

- BALLHAUSEN, C. J. (1962): *Introduction to ligand field theory*. McGraw-Hill, New York.
- BARTH, T. F. W. (1937): Crystallographic studies in the vivianite group, *Am. Min.* **22**, 325.
- COTTON, F. A. & WILKINSON, G. (1962): *Advanced inorganic chemistry*. Interscience Publishers, John Wiley and Sons Inc., New York.
- FAYE, G. H. & HORWOOD, J. L. (1967): Correlation of absorption spectra and structure of some Co(II) and Ni(II)-2,2'-biquinoline complexes. *Can. J. Chem.* **45**, 2335.
- FAYE, G. H., MANNING, P. G. & NICKEL, E. H. (1968): An interpretation of the polarized optical absorption spectra of tourmaline, cordierite, chloritoid and vivianite: $\text{Fe}^{2+} \rightarrow \text{Fe}^{3+}$ electronic interaction as a source of pleochroism. Submitted to *Am. Mineral.*
- FERGUSON, J., WOOD, D. L. & KNOX, K. (1963): Crystal-field spectra of d^8 , d^7 , ions. II. KCoF_3 , CoCl_2 , CoBr_2 and CoWO_4 , *J. Chem. Phys.* **39**, 881.
- LEVER, A. B. P. & OGDEN, D. (1967): Haloacetate complexes of cobalt(II), nickel(II), and copper(II), and the question of band assignments in the electronic spectra of six-coordinated cobalt(II) complexes. *J. Chem. Soc. (A)* 2041.
- MORI, H. & ITO, T. (1950): The structure of vivianite and symplectite. *Acta Cryst.* **3**, 1.
- PAPPALARDO, R. (1959): On the low temperature optical absorption of $\text{CoCl}_2 \cdot 6\text{H}_2\text{O}$ and $\text{CoBr}_2 \cdot 6\text{H}_2\text{O}$. *Phil. Mag. 8th Series*, **4**, 219.
- WINCHELL, A. N. (1951): *Elements of optical mineralogy*, Part II, Fourth ed. John Wiley and Sons Inc., New York.

Manuscript received, March 16, 1968, emended April 17, 1968