

# THE AMERICAN MINERALOGIST

JOURNAL OF THE MINERALOGICAL SOCIETY OF AMERICA

VOL. 14

DECEMBER, 1929

NO. 12

## A MODIFIED UNIVERSAL STAGE

R. C. EMMONS, *University of Wisconsin.*

### SUMMARY

The purpose of this paper is to describe a microscope method for determining principal refractive indices by the immersion method using the universal stage. From any one grain of a biaxial mineral of moderate birefringence, regardless of its original orientation, it is possible to measure all three refractive indices. A new universal stage is described which permits the operator, after orienting a mineral in such a way that X, Y or Z is parallel to the axis of the microscope, to rotate the crystal on *either* of two mutually perpendicular horizontal axes. The last step is possible only on the modified stage. Also a water cell is described which makes possible the variable temperature control of the mount. The "Double Variation" procedure with the universal stage is outlined. If X (or Y or Z) is parallel to the axis of the microscope and two critical indices are determined, it may not be possible to rotate a full 90 degrees to obtain the third index. A procedure is given whereby the index is read at a chosen rotation and a graph gives the correct extrapolation for the 90 degree position. The attempt is made to avoid all graphical construction on the part of the operator and to present a procedure which is only a modification of the standard immersion methods so widely used in America. For the writer the universal stage, instead of being an accurate but time consuming instrument, has become a time saving instrument with added accuracy.

Recently in connection with some experiments on a new method of mineral refractive index determination which involves the combination of both temperature and wave length control,<sup>1</sup> the writer had reason to believe that the universal stage might be employed to advantage. But it seemed that the complexity of the manipulation of the standard stage is such that American petrographers probably could not be persuaded to use it. As an outgrowth of this realization a Leitz model of a Fedorow stage was modified by the addition of one more horizontal axis of rotation. The new axis is parallel to the east-west horizontal axis. The addition of this axis, although complicating the manufacture of the stage, very greatly simplifies the manipulation. The Bausch and Lomb Optical Company has already done considerable work toward the commercial manufacture of the stage as described in this paper.

<sup>1</sup> R. C. Emmons, *Am. Mineralogist*, Vol. 13, 1928, p. 504; *Am. Mineralogist*, Vol. 14, 1929, p. 414.

America's foremost petrographers have for more than twenty years pointed out the great advantages of the universal stage, but still this instrument is scarcely used in America, although in Europe it is employed extensively. There are, of course, several good reasons for its slow adoption in this country—two of these will be mentioned. First, the universal stage in its present form is admittedly complicated and certainly too involved for routine petrography. Second, the analysis of results obtained from universal stage observations involves lengthy and cumbersome graphical procedures which to quote F. E. Wright, have caused the stage not to be adopted "so rapidly and generally as might have been anticipated."<sup>2</sup>

The use of the standard universal stage requires time consuming manipulation and considerable indirect reasoning that does not appeal to the routine petrographer, who as a rule is more interested in direct observations. In the present article an attempt is made first to describe a modified universal stage and its manipulation, and second, to state a procedure which has been reduced to a simple routine almost as direct as the customary procedures and observations of the American petrographer.

I have experienced difficulty in instructing students in the use of the standard Fedorow stage for routine work, such as in the determination of feldspars. Accordingly it was with no small interest that I recently tried out the new model on a group of eight students selected from a class in petrography. It was highly gratifying to find that at the end of one hour's instruction the men were able to make certain routine tests, and they expressed genuine satisfaction with the simplicity of the manipulation of the new model. The great utility of the universal stage is of course unchallenged.

The one limitation of the standard universal stage which has been a source of considerable annoyance to me is the inability to rotate a crystal on two mutually perpendicular and horizontal axes after the crystal has been oriented with one of the axes of the optic indicatrix vertical. The reason for this lies in the fact that a rotation on the east-west horizontal axis is almost invariably necessary in order to bring one of the desired mineral axes into a vertical position and such a rotation inclines the only other horizontal axis (north-south) so that the plane of its rotation is no longer vertical. Accordingly in the modified stage there are two

<sup>2</sup> F. E. Wright, *Methods of Petrographic Microscopic Research*, p. 176.

horizontal east-west axes of rotation. Otherwise it is quite the same as the standard stage.

A detailed description of the recommended procedure is given below, but for those familiar with the universal stage the difference in manipulation (see Fig. 1) may be summarized as follows:—instead of making the selected vibration direction parallel to the N-S cross-hair, make it parallel to the E-W cross-hair and by suitable manipulation in the standard way, but using the inner E.W axis of rotation, make an optic symmetry plane parallel to the E-W nicol; that is, vertical. Now by rotation on the N-S horizontal axis one of the vibration directions, X, Y, or Z, two of which lie in this vertical symmetry plane, may be made parallel to the axis of

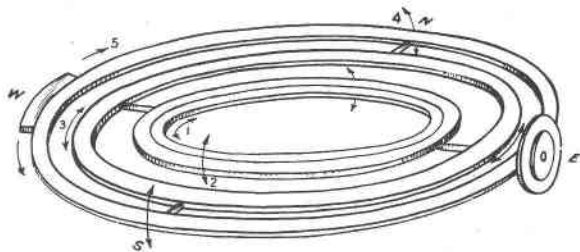

1. Inner stage vertical axis rotation.
2. Inner stage E.W. horizontal axis rotation.
3. N.S. horizontal axis rotation.
4. Outer stage E.W. horizontal axis rotation.
5. Outer stage vertical axis rotation.

Figure 1. Diagrammatic representation of the modified stage showing the added inner E-W axis, and the rotational movements of all axes.

the microscope. In other words, the crystal in this way may be oriented for the universal stage. It now can be rotated in two mutually perpendicular and vertical planes on the two horizontal axes—both of which *are* horizontal. Furthermore, the actual time required to secure this position is but slightly greater than that required to make only one of the symmetry planes perpendicular and is equally simple to do. It is unnecessary to make two or three initial planes of symmetry parallel to a nicol, as is done in using the standard universal stage, and this affords a considerable saving of time. It is also unnecessary to graph information except for purposes of record and detailed accuracy, and to bridge the gap between two quite separate positions of the stage—a bridge which few American petrographers care to take the time to make. Moreover, it becomes a very convenient procedure both to test two sym-

metry planes from one position for optic axes, and to secure a position in which two known critical rays are being transmitted. It is also sometimes possible to test three symmetry planes and, therefore, to obtain three critical rays from one grain. Although it is impossible to obtain interference figures with the universal stage, still, these figures are not essential, and this limitation is not serious.

The manipulation of the universal stage is as complicated as many phases of crystal optics. The average student of petrography is very apt indeed on completing his course in fundamentals to forget a great many of them, even before his university training is completed. Possibly this situation, which unfortunately is quite general, also offers in part an explanation for the limited popularity of the use of the universal stage. In any case, a brief summary of the vibration directions within the optic indicatrix, as it bears on this problem, may well be given here. Biaxial crystals will be treated first and uniaxial crystals, whose manipulation on the universal stage is much simpler, will follow. Throughout, the main purpose here is to secure positions in which critical rays are transmitted, the ultimate objective being the study of powdered minerals. Thin section study is somewhat similar.

#### BIAXIAL CRYSTALS

In the optic indicatrix of a biaxial crystal there are three planes of symmetry which are mutually perpendicular. Each pair intersects, therefore, along a line which is perpendicular to each of the other lines of intersection. All three lines of intersection cross at a point which is the theoretical center of the figure.<sup>3</sup> All the rays in which we are interested vibrate in these three planes since the optical constants of a biaxial crystal are studied only in crystal positions such that the axis of the microscope lies in at least one of the planes of symmetry. When this condition is fulfilled, the line of intersection of the other two planes is perpendicular to the axis of the microscope. This line of intersection is always one vibration direction of the light transmitted. When this line is parallel to one of the nicols the crystal is, of course, in a position of extinction. The other vibration direction lies in the plane of symmetry which includes the axis of the microscope; it is perpendicular to the first

<sup>3</sup> The initial study of the universal stage may be greatly simplified by cutting and folding a piece of paper so as to represent three mutually perpendicular planes. This model may be rotated with the stage in the following discussion.

and also perpendicular (or nearly so) to the direction of propagation of the transmitted light.

Normally a crystal fragment or thin section of a crystal suitably mounted on the microscope stage is so oriented that the axis of the microscope lies diagonally in one of the indicatrix octants and not in one of the planes of symmetry. The first step in orienting the grain is to make one of the planes of symmetry parallel to one of the nicols. To do this two rotations of the stage are needed. Let us first, for the sake of simplicity, review the construction of the stage and indicate a suitable terminology.

The modified stage has six axes of rotation which, from the center out, are as follows:<sup>4</sup> First, a *vertical inner stage rotation axis* (See Fig. 1). This is used to turn the grain to extinction. Second, an *inner east-west horizontal axis*. This is used to tilt the grain after extinction is reached in order to bring the first optic symmetry plane into a position parallel with the E-W nicol. Third, a *north-south horizontal axis*. This is used to bring one of the critical vibration directions which lies in the first selected optic symmetry plane into a position parallel with the axis of the microscope. It is also used to search the first selected symmetry plane for optic axes as shown in detail below. Fourth, an *outer east-west horizontal axis*. The graduation on this axis carries a vernier. It is used to search the second optic symmetry plane for optic axes and it is also used to measure the optic angle in either plane, if the optic plane is identified as one of them. Fifth, a *vertical outer stage rotation axis*. This is used to rotate the first optic symmetry plane into a north-south position in case it should be found to be the optic plane. This makes it possible to measure V or 2V on the vernier scale. Berek uses this rotation to measure the optic angle indirectly. Sixth, the rotation of the microscope stage, or better still as on some microscopes, the *rotation of both nicols* simultaneously. This is used when making the actual measurement of the optic angle. The nicols are rotated to the 45 degree position which gives the sharpest extinction when an optic axis is brought parallel to the axis of the microscope. The order in which these rotations are described is essentially the order in which they are used.

Now to return to the selected grain the orientation of which is

<sup>4</sup> The reference names for these axes as given here are not standard but are ones that I have suggested. They seem to me to be short and more obvious than numbers as used by Berek and others. In giving instruction to a limited number of students in this field these names have proved satisfactory.

not known, but is safely assumed to be such that X, Y, and Z are all inclined to the axis of the microscope and to the stage of the microscope. Using the vertical inner stage rotation, turn the grain to a position of extinction. This position will suffice as a starting point without the next step, but the procedure is somewhat simplified if the next step is taken. Next rotate separately on each of two mutually perpendicular horizontal axes of rotation, and note on which axis the grain departs least from extinction. Then rotate 90 degrees if necessary on the vertical inner stage axis to make a rotation on the north-south horizontal axis depart least from extinction. Now the grain is so oriented that when all horizontal axes read zero the steepest optic symmetry plane strikes in a general east-west direction and dips either north or south. The steeper the dip the less is the departure of the strike from a true east-west direction.

To make this symmetry plane parallel to the east-west nicol the procedure is as follows: Rotate a few degrees on the inner E-W horizontal axis in either direction. This causes the crystal to depart from extinction. Bring the crystal back to extinction by a small rotation on the inner stage vertical axis. Now if the first of these two rotations was made in the right direction the crystal in its new position may be rotated on the N-S horizontal axis and the departure from extinction will be less than before. If the departure from extinction is greater than before then this first rotation was in the wrong direction. In other words, it must be determined empirically whether the first selected optic symmetry plane is dipping north or south. Having decided in which direction to rotate the crystal on the inner stage E-W horizontal axis, then by successively rotating on this axis a few degrees, returning the crystal to extinction by a rotation on the inner stage vertical axis and testing by a rotation on the N-S horizontal axis, the first selected optic symmetry plane is made parallel to the E-W nicol. Parallelism is obtained when a rotation on the N-S horizontal axis does not disturb extinction. This operation is a "cut and try" procedure and is, therefore, the most difficult and unsatisfactory feature of the universal stage manipulation. However, with a little practice it requires very little time. We have now made the first optic symmetry plane parallel to the E-W nicol. We may safely assume that the other two symmetry planes, which we know are striking true north and south, dip one east and one west. There is only a theoretical possibility that one is vertical and one horizontal.

The next step is to make one vertical and one horizontal, or in other words, make two of the directions X, Y, Z horizontal, and one parallel to the axis of the microscope. Attention is called to the fact that the verniers of both of the other horizontal axes (i.e. the outer E-W and the N-S horizontal axes) still read zero. The ray which is vibrating parallel to the N-S nicol is one of the critical rays vibrating parallel to X, Y, or Z. The N-S horizontal axis is parallel to this vibration direction. Therefore, this axis (N-S) lies in each of the other two optic symmetry planes and a rotation on it in one direction tends to make one of these planes parallel to the N-S nicol, and in the other direction to make the other plane parallel to the nicol. But the grain is now at extinction which is the only criterion under the circumstances for knowing when an optic symmetry plane is parallel to the nicol. Therefore, on the outer stage E-W horizontal axis rotate a few degrees thereby causing the crystal to depart from extinction. Then rotate on the N-S horizontal axis (now slightly inclined) in either direction until extinction is secured. Now return the outer stage E-W horizontal axis to its zero reading and the crystal is oriented for the universal stage. The last rotation on the N-S horizontal axis can commonly be made either way. It can be made in one direction only if one of the other optic symmetry planes that is being sought is dipping steeply. Then a small rotation in one direction brings extinction and a large rotation in the other direction may fail to bring extinction. If it is possible to obtain extinction both ways, then all three symmetry planes may be made parallel to the nicols, two at a time; also, all three rays vibrating parallel to X, Y, and Z, may be transmitted, two at a time.

Knowing the orientation of the grain, the operator turns next to a determination of the optic plane and a measurement of the optic angle. Rotate the nicols to the 45 degree position, (or if the microscope is not equipped for the simultaneous rotation of the nicols, rotate the stage of the microscope). Then rotate the crystal from its oriented position, first using the outer stage E-W horizontal axis and second the N-S horizontal axis. If on either rotation extinction is reached, then this extinction position is an optic axis position. Since the nicols are at 45 degrees to the planes of symmetry, which in turn include the only possible vibration directions for the orientations being used, then it is only when the direction of transmission is parallel to an optic axis that the plane of vibration

of the polarizer is not rotated in the mineral, and extinction results. The optic axis position may be checked readily by rotating either the nicols or the stage of the microscope—extinction should persist. Measure the angle of rotation required—either it or its complement (corrected for refractive index as shown below) is  $V$ . If the optic plane proves to be the E-W (i.e. the first selected) symmetry plane then it is well to rotate the mount through 90 degrees on the outer stage vertical axis. Then the symmetry plane is in the N-S position and  $V$  may be measured on the vernier scale of the outer stage E-W axis. If neither of the vertical symmetry planes is the optic plane then the horizontal plane must be. It may or may not be possible to make this plane vertical. If not, then a slight movement of the grain is likely to be sufficient to give a more favorable orientation. The entire procedure must of course be repeated again but with very little practice it should take only a few minutes.

Unless the mineral is one of low birefringence readings of quite satisfactory accuracy<sup>5</sup> may be obtained for  $2V$  by direct measurement if the proper conditions required for the illumination of the stage are observed. These are given in a later paragraph. If for any reason the optic angle is not measured directly, it can be easily calculated from the determination of refractive indices toward which this procedure is leading. Or  $2V$  may be obtained from Wright's graph reproduced here.

#### UNIAXIAL CRYSTALS

Uniaxial crystals may be oriented much more simply. For any position of extinction of a uniaxial crystal the plane of vibration of one of the nicols includes the optic axis of the crystal. If then the crystal is rotated on an axis perpendicular to this plane, the optic axis must still remain in the plane—or, the crystal in other words, will remain at extinction. If, on the other hand, the crystal is rotated on a horizontal axis which lies in the plane to which the optic axis is parallel, then the crystal will depart from extinction unless the optic axis is either parallel or perpendicular to the rotation axis. For otherwise, the optic axis is rotated out of a position of parallelism with one of the nicols.

In order to orient a uniaxial crystal, this line of reasoning may be reversed. Turn the crystal to extinction on the vertical inner stage

<sup>5</sup> Wright describes a method that is still more accurate but quite lengthy and tedious. It consists in plotting the optical curves of Fedorow in projection and locating the optic axis at the midpoint of intersection. *Idem*, p. 179.



axis. Rotate on first one horizontal axis, then the other perpendicular to it. On one of these rotations the crystal will remain at extinction. The optic axis lies in the plane that is perpendicular to this axis of rotation. There are two theoretical possibilities that the crystal will remain at extinction on both rotations—the optic axis is either horizontal or vertical and, therefore, on either rotation it is parallel constantly with the vibration plane of a nicol. If the optic axis is horizontal, the crystal will show its maximum birefringence in the 45 degree position, and if vertical, it will show no birefringence in the 45 degree position.

The recommended procedure, then, is to select a grain of rather high birefringence. Turn to extinction. Rotate on each of the two horizontal axes in turn and note on which rotation the crystal remains at extinction. Make this the N-S axis by a 90 degree rotation if necessary on the inner stage vertical axis. Then rotate slowly on the N-S axis in one direction until it is possible to rotate on the E-W axis without departing from extinction. If a crystal of relatively high birefringence was selected, then only the position of maximum birefringence can be reached, that is, it is possible to make the optic axis horizontal but probably not vertical. However, the vertical position is not needed except to test for a small optic angle. In the horizontal position both of the rays wanted are transmitted.

#### UNIVERSAL STAGE CONDITIONS

In general all crystals are oriented on the basis of extinction. To recognize an extinction position accurately is critical. As pointed out by Wright and others the correct position is not always the darkest as it would be for perfectly parallel light but it is a position of comparative darkness, the intensity of which does not change on the various selected rotations. Some prefer to insert a sensitive tint plate over a mineral at extinction, reduce the ocular diaphragm to exclude other minerals and to note changes in the sensitive tint as a test of extinction.

The conditions required for universal stage work are given in most modern texts on the subject. For minerals of high birefringence fewer precautions are necessary. But since most minerals commonly handled do not have high birefringence, it becomes necessary to employ added refinements of procedure for which we are largely indebted to Berek.<sup>6</sup> The light should be as nearly paral-

<sup>6</sup> M. Berek, *N. Jarb. Min., Beil. Bd.*, XLVIII, 1923.

lel as possible. To obtain this the diaphragms below and above the polarizer should be closed. Also, the diaphragm in the objective, if one is available, should be closed to exclude reflections, but quite satisfactory results can be obtained without this. With these diaphragms closed an intense source of light is needed for which an arc lamp serves well. If monochromatic light is employed from a monochromator, then the diaphragms need not be closed as other conditions supply the parallelism required. In my own work, in which I employ the universal stage almost exclusively in connection with the double variation method, a conveniently placed swing-out mirror between the arc lamp and monochromator serves to illuminate the microscope with either monochromatic light or the direct beam of the arc lamp. A low power objective is used—Nos. 1 or 2, or 32 or 36 mm.

The stage should of course be properly centered so that the three vertical axes coincide and the three horizontal axes are properly aligned with the nicols or cross hairs. To check the alignment of the horizontal axes the simplest procedure is to raise the objective until it is focused upon the surface of the upper hemisphere, then rotations on the horizontal axes should cause dust particles in focus to move parallel to the cross hairs.

Directions of light transmission within mineral grains mounted on the universal stage are modified on entering the upper hemisphere in quite the same way that these directions are modified on passing into the air from a microscope slide. If the mineral has a refractive index greater than that of the upper hemisphere, then the apparent direction of transmission makes a greater angle with the perpendicular to the inner stage than does the true direction of transmission. Hemispheres of two refractive indices are, therefore, provided for convenience. Apparent angles as read on the scales of the horizontal axes of the universal stage are simply corrected by knowing the refractive indices of the hemisphere and of the mineral. For this purpose a graphic solution is provided in most standard texts, designed after Fedorow. This is reproduced in Plate 1, with explanation. *Therefore, all vertical angles as read on the arcs of the universal stage must be corrected by this diagram to obtain a true figure.* There is here also the added advantage over thin sections that for this correction in working with powdered material the exact indices are known. It is sometimes advantageous when a large angle is to be read to use a high index hemisphere, even on a

mineral of comparatively low index, as this decreases the apparent angle.

#### TEMPERATURE CONTROL

In order to apply the principles of the double variation method of mineral determination variable temperature control of the mount is required. To accomplish this a special water cell has been designed for the universal stage, and is intended to be connected in series with the water circuit of the refractometer. The cell is shown in Figure 2. It consists of a metal disk in the center of which is mount-

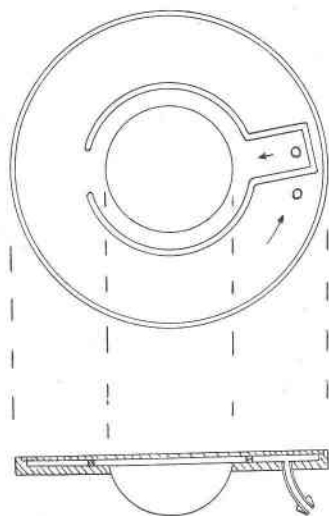

Figure 2. Water cell for the Universal Stage to be connected in series with the refractometer and to give controlled temperature of the immersion medium in which the crystal being studied is mounted.

ed the lower hemisphere. This constitutes the lower side of the cell. The upperside is the central glass disc of the universal stage cemented to the metal disk along a raised margin. This is so adjusted as to leave a space between the metal and glass discs equalling in dimension the thickness of a microscope slide. It is through this space that water flows. The water is so directed by partitions within the cell that it flows directly across the center of the cell and returns around the margin. The intake and outlet tubes lead from the lower surface of the cell at one side. The cell is designed, of course, to fit in the place of the central glass discs of the stage. In making mounts no slide is used, but a cover glass is placed directly

on the upper surface of the cell, then the mount on this cover and another cover glass over this. The upper hemisphere is then clamped into position—all with suitable liquid contacts.

The method described by Ashton and Taylor was employed<sup>7</sup> to determine the approximate temperature given by this cell. The "cold" junction of a thermocouple was placed in the refractometer and the "hot" junction was placed in the position of the mount on the cell. Readings were made on a Hoskins type H. A. "Thermoelectric" pyrometer. Readings are accurate to one-half a degree, and by interpolation, one quarter degree readings could be estimated. The readings indicate *differences* in temperatures between the liquid on the refractometer and that on the cell. The results follow:

ROOM TEMPERATURE 28°C. INDICATED TEMPERATURES READ ON THE  
REFRACTOMETER THERMOMETER

At 27°	after two minutes	the temperature difference	is	0°
At 32.3°	" three	"	"	" 1°
At 32.3°	" five	"	"	" ¼°
At 48°	" two	"	"	" 5°
At 48°	" five	"	"	" 1°
At 48°	" ten	"	"	" ¼°
At 19°	" one	"	"	" 2°
At 19°	" three	"	"	" 1¾°
At 19°	" five	"	"	" 1½°

The greatest difference in temperatures is found at the lower end of the scale rather than at the upper end. Not only is this true but the difference between the readings of the thermometer before the refractometer and that after this water cell, or any other water cell that I have used, is always greater at the lower temperatures. For the reading given above of 19° on the refractometer thermometer the corresponding reading on the second thermometer was 20°. The explanation is not obvious.

#### MOUNTING PROCEDURE

The procedure for using thin sections differs somewhat from that for work with powders. For thin sections place a drop of oil on the central glass disc and one on the top of the cover glass. The lower and upper hemispheres are then put in place, all contacts being made with oil. This procedure is standard. If the powder mount is

<sup>7</sup> F. W. Ashton and W. C. Taylor. A Precision Method for the Determination of Refractive Indices. *Am. Mineral.*, Vol. 13, p. 411, 1928.

being made without the water cell described above, then a standard mount is made on a slide in a suitable liquid, and suitably covered. This is then mounted in the same manner as the thin section. If the water cell is used, then the powder is mounted between two cover glasses, the lower of which protects the central glass disc of the stage and cell and the upper protects the upper hemisphere. All contacts are made with the same liquid to avoid possible contamination. It has been stated that the upper surface of the cell is at a height on the stage equivalent to the upper surface of a glass slide resting on the standard central glass disc. Therefore, the powder mounted on the water cell, without a glass slide, is properly centered. Before placing the upper hemisphere, center a suitable grain. If ordinary oils are used, it is necessary either to use very few grains or to select a large one for observation, since the viscosity of the liquids is too low to support grains which are not held in position by the two cover glasses. The upper hemisphere must be clamped into position gently to avoid shattering grains. The particular immersion liquid used is one selected after a brief study of the mineral in the ordinary way. The greater facility of the daily procedure makes a cursory preliminary examination in this way highly desirable before attempting to use the universal stage.

#### THE DETERMINATION OF REFRACTIVE INDICES

The universal stage as used in Europe involves an amount of plotting that for the American renders its usefulness questionable because of the consequent time consumption. The procedure as outlined here leads to a determination of the principal refractive indices which American petrographers have consistently emphasized. The chosen method of comparative index determination is one of the two most widely used—the Becke line method.

The Becke line method when employed with the universal stage is outstandingly satisfactory. The commonly given text-book explanation that the Becke line results from light refracted at a surface between two substances that is perpendicular to the cover glass is doubtless satisfactory in some instances in thin section work. But most petrographers do not rely upon this explanation for immersed powders, rather, the effect results from the roughly lenticular shape of the grain. It is dependent for sharpness then, upon parallel light, an effect that is commonly gained by lowering the substage. The universal stage with the added distance between

the microscope stage and the mount is, therefore, particularly well suited to the Becke line method. And this is well borne out by experience, for a suitable mount on the universal stage gives a very strong Becke line with both white and monochromatic light, using either a No. 1 or No. 2 objective. When using white light, if the index of the mineral and liquid coincide for light of one wave length, then the dispersion of the rays is very marked unless the dispersion of the mineral is high, and nearly equal to that of the liquid. In short, the Becke line on the universal stage is at least as satisfactory as under the most favorable circumstances in standard use. Therefore, by employing monochromatic light of variable wavelength, a very accurate coincidence of indices can be secured.

It is almost always possible to rotate any grain on the universal stage sufficiently to make two of the symmetry planes of the optic indicatrix perpendicular; that is, to secure two of the principal rays. But it is not often possible to rotate from this position through a sufficiently large angle to secure the third principal ray. It is possible, however, to rotate through a considerable angle on the horizontal axis that is perpendicular to the plane of the vibration of the polarizer, though it may be necessary first to rotate  $90^\circ$  on the vertical outer stage axis. Now the refractive index may be measured in this new position. Knowing the refractive index before rotation on the horizontal axis and knowing the angle of rotation (corrected for refractive index-Plate I) and, therefore, the difference in index, it is possible to calculate the correct extrapolation to obtain the other principal index at  $90^\circ$  to the first. The greater the extrapolation the less accurate will be the final determination but, fortunately, it is usually possible to rotate through a considerable angle. To facilitate this detail of the procedure a graphical solution of this calculation is offered in Plate II.<sup>8</sup> This diagram holds for any direction in a uniaxial crystal and for any direction of rotation within a plane of symmetry of a biaxial crystal. All angular measurements are made from principal positions.

Even though the double variation method of index determination is used, it is not always possible to bring about sufficient variation to reach the second principal index after the first has been determined. For such minerals of rather high birefringence if the

<sup>8</sup> In constructing this graph I have consulted with R. W. Babcock of the department of Mathematics and have received considerable help from him on the proof of it.

second index on rotation on a horizontal axis perpendicular to the plane of vibration of the polarizer, approaches the first, which it must do half the time, then by the following procedure both the second and third indices may sometimes be determined. Rotate sufficiently to bring the second index within the range of the liquid and determine it. Then continue to rotate in the same direction as far as possible toward the third critical position and make another determination. Using the diagram (Plate II) after correcting for indices (Plate I), locate two points on the proper degree of rotation lines such that the vertical (or horizontal) intercept of the points indicates the proper index difference obtained from the two readings. Also both points must fall on the same inclined line. This inclined line gives at its extremities the total difference in index between the second and third principal rays. On the ordinate and abscissa can be read the difference in index between the principal indices and those determined. Therefore, the principal indices can be determined by simple addition and subtraction. If the mineral is one of high birefringence then this procedure fails.

Attention should be called to the fact that if the critical positions in which principal rays are transmitted are not accurately secured, the error in index is very small indeed as may be read from the diagram. But if the positions in which partial birefringence is read, especially near  $45^\circ$ , are not accurately determined then the error is considerable.

#### SUMMARY OF PROCEDURE

The mineral under study in powder form is cursorily examined on an ordinary glass slide to locate roughly its position on the refractive index scale. This information is used to select the proper "double variation" liquid for detailed study. A very few grains are then mounted between two cover glasses in the chosen liquid and are placed on the universal stage with the same liquid contacts, using the special water cell. One grain is centered and the upper hemisphere clamped in place. Using the direct illumination of an arc lamp, orient this grain so that X, Y or Z is parallel to the axis of the microscope. Then determine the indices of one or both of the rays transmitted, using temperature and wavelength variation. Rotate in a plane of symmetry to the third critical position if possible and determine the third index. Or, if this is impossible, then rotate as far as possible toward this position and determine the index.

By using Plate II extrapolate to obtain the correct index. The first index determined by the double variation method usually gives the dispersion curve for the mineral. For the other indices any one point on the dispersion curve, that is, a determination at any one wavelength is often sufficient since for many minerals the dispersion for the various rays is almost equal.

#### CONCLUSION

Nothing has been said of graphical methods of representing observations and drawing conclusions. Graphical methods have been worked out in great detail and have been adequately described in several languages. Wright's well-known book<sup>9</sup> presents them in authoritative form for the English reader. It is doubtful if these methods which have been available for a long time will ever become popular in this country. This paper is intended to develop for the universal stage a technique that avoids graphical construction, and enables the operator to make direct observations of the kind the American petrographer is accustomed to make and to represent his results in the same terms that he has been using.

This paper is intended to be the third and final article by the writer on the subject of the "Double Variation Method of Mineral Determination." The two previous papers have been referred to in footnotes.<sup>10</sup>

There is especially one particular improvement which I should like to see made; an immersion medium is needed of essentially infinite viscosity at the temperatures at which the work is done. It must of course have high dispersion and a high thermal coefficient of refraction. It should be either variable in index by the addition of some other material or it should be one of a series. And it should be soft or melt at 50-70° C. I have tried water solutions of pectin, several gums, gelatin, etc., but none tried thus far have sufficient viscosity to support the smaller grains when the stage is tilted. Or, if they possess the necessary viscosity they are not suitably transparent. The resins have been suggested but do not seem entirely satisfactory. When a suitable medium is found it will avoid the necessity of using either a few grains or well sized grains.

<sup>9</sup> F. E. Wright, *Methods of Petrographic Microscopic Research*, 1911.

<sup>10</sup> While correcting proof of this article, Dr. T. Ito of the Imperial University of Tokyo visited our department. He informs me that he published in Japanese, *Jour. Geol. Soc. Tokyo*, 1924, a note descriptive of the use of the universal stage for immersion work.



By the method outlined here all three indices of refraction of any one grain of a biaxial mineral of moderate or low birefringence may be determined with both accuracy and comparative speed. The limiting factor lies in the index range of the immersion medium at the maximum suitable variation of temperature and wave length.

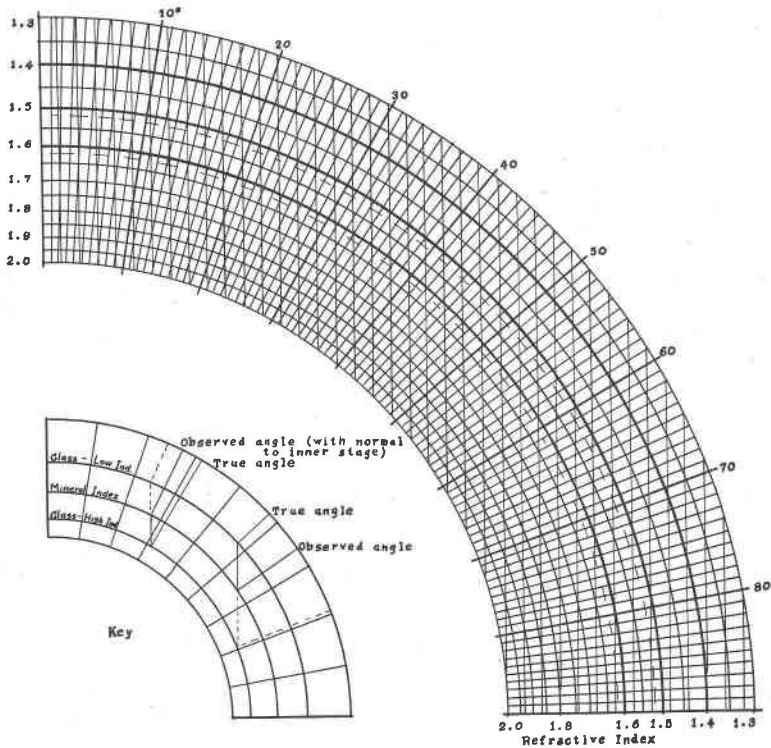

Plate I. Graphical Solution (after von Fedorow) of the equation  $\sin i = n \sin r$ . This is used to correct angular readings between the normal to the inner stage (or the section) and the direction of observation. The correction is based on first the index of the mineral, and second the index of the glass hemisphere that is being used. All angles to be used on Plate II must first be corrected on this graph or its equivalent. The procedure is shown in the key,—the observed angle as read on the scales is traced from the circumference to the circle which indicates the index of the mineral, from here along a vertical line (up or down) to the circle which indicates the index of the glass hemisphere, and from here radially to the circumference on which the true angle within the mineral is read.

Plate II. Graphical solution of the equation  $\epsilon_1 = \epsilon\omega / \sqrt{\omega^2 \sin^2 \phi + \epsilon^2 \cos^2 \phi}$  and similar equations for the ellipses of the planes of symmetry of the optic indicatrix of a biaxial crystal. The large triangle will serve most practical purposes, the small triangle is intended for minerals of high birefringence. For the large triangle (and all ordinary work) no correction need be made for the position of the mineral on the refractive index scale. But the corrections given must be applied with the small triangle.

The use of the diagram may be outlined as follows:

Assume that a mineral has been oriented with X, Y or Z parallel to the axis of the microscope which can always be done and that two indices have been determined in this position by the double variation method. Assume further that it is impossible to rotate on a horizontal axis through  $90^\circ$  to either one of the other two principal positions, which is a common difficulty. Then rotate, with the grain at extinction as far as is conveniently possible on that horizontal axis which permits the greater rotation (up to  $90^\circ$ ), and rotate the lower nicol (or the stage) if necessary to make its plane of vibration perpendicular to the axis of rotation. Note the amount of rotation on the horizontal axis and correct it according to Plate I. Measure the refractive index in the new position and find the difference in index between this value and that of the principal index already measured for the ray which vibrates in the same plane. This difference is found on the ordinate or abscissa as follows: If the rotation has caused a change from a greater to a smaller index, use the ordinate scale, if the rotation has caused a change from a smaller to a greater index, use the abscissa scale. Follow this value horizontally (or vertically) to the intersection with the proper degree of rotation line. Then follow the inclined line to its extremity where is indicated the total difference in index for a full  $90^\circ$  rotation. By simple addition or subtraction the third principal index may then be found.

For minerals of higher birefringence the smaller triangle is used similarly with this difference—if the index is not that for which the diagram was constructed, then a small correction must be applied. First determine the total difference in index as outlined for a  $90^\circ$  rotation. Select the proper small plat, follow the proper total "index-difference" curve to its intersection with the "degree-of-rotation" line (vertical) at which the reading was made. The correction is at the left.

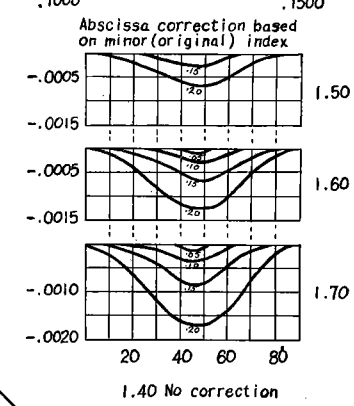
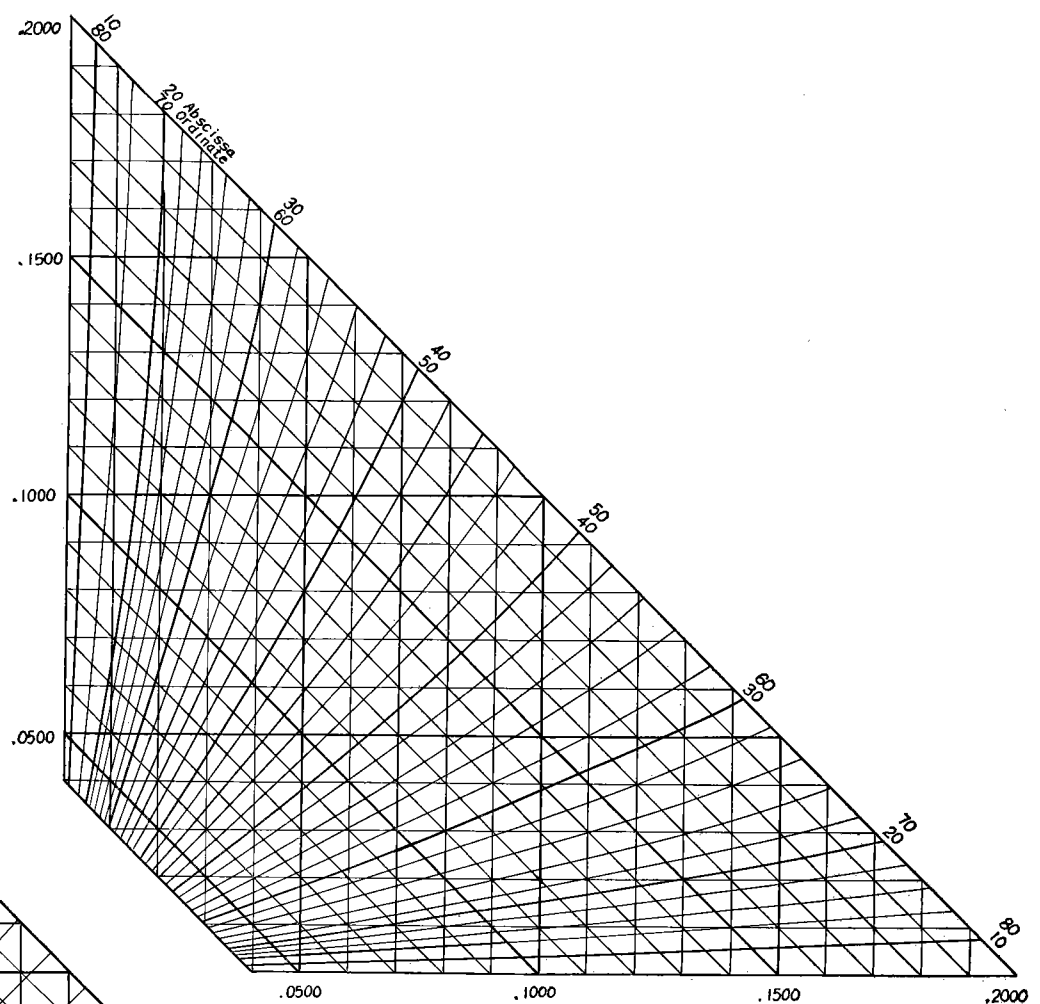
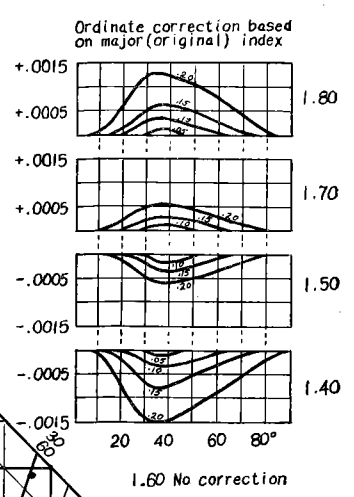
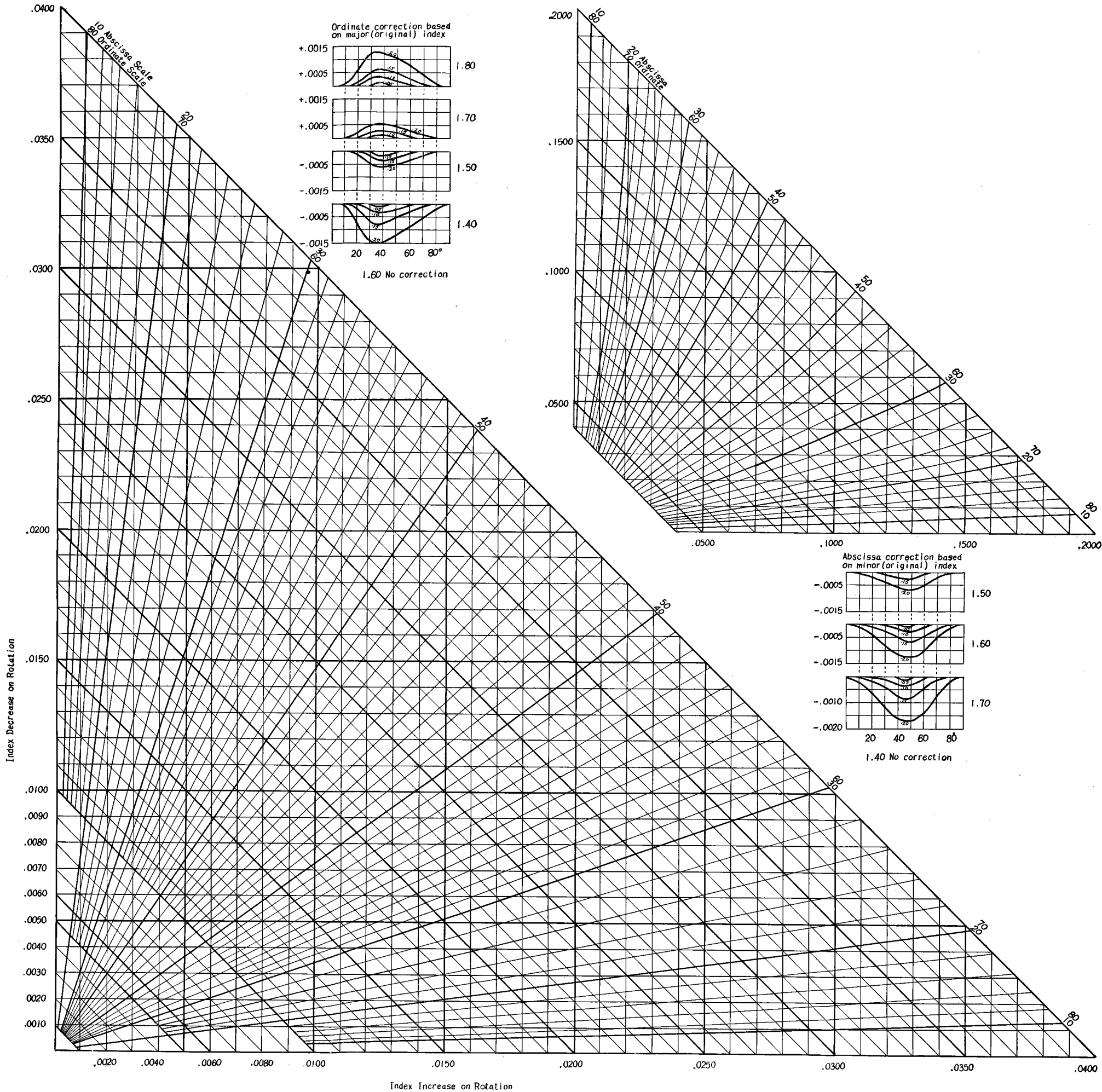

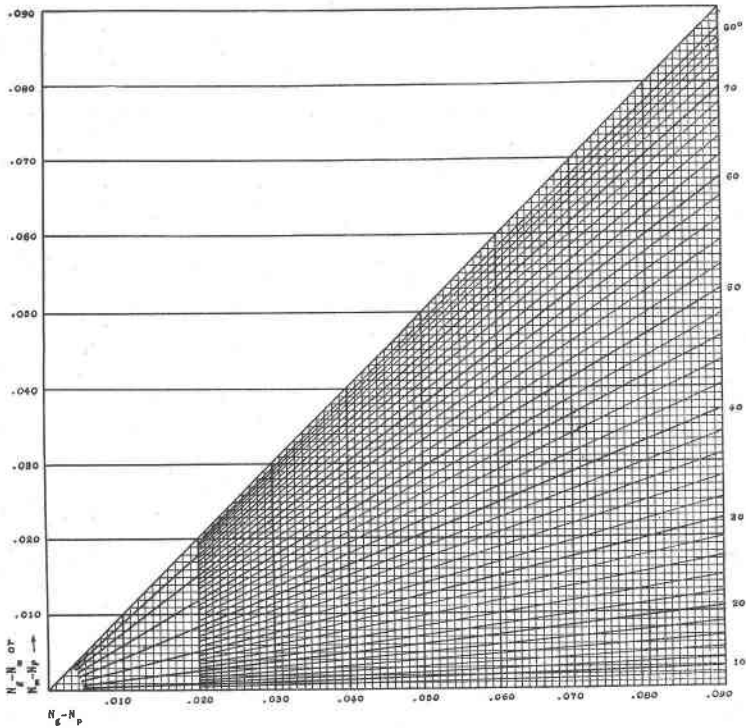

Plate III. Graphical solution (after Wright) of the equation  $\sin^2 V = n_m - n_p / n_o - n_p$ . Knowing by the procedure outlined the three principal refractive indices of a crystal, the optic angle can be obtained quickly by means of this graph. If the optic angle was measured directly on the universal stage as is frequently possible, then this gives a convenient check on the refractive indices. Total birefringence ( $n_o - n_p$ ) is found on the abscissa and the partial birefringence ( $n_o - n_m$  or  $n_m - n_p$ ) is found on the ordinate. The inclined lines indicate  $V$ .

## PLATE IV

EXPLANATION: The purpose of this plate is to trace the movements of the perpendicular to the inner stage on the various rotations. It is a substitute for the Nikitin hemisphere. It gives at all times the angular distance of the perpendicular to the inner stage from the axis of the microscope. This angle is corrected for refractive index on Plate I. After making the corrections and locating the modified positions on this plate, then such angles as  $V$  or  $2V$ , and angles to be used on plate II may be read. This plate is a stereographic projection of angular rotations in divisions of  $10^\circ$ . For a great many determinations in which the angles of rotation are not large or the indices of the mineral and glass hemisphere do not differ greatly, it is unnecessary to use this plate as the error is small.

*Example* used in the key

Index of the mineral	1.70
Index of the hemisphere	1.60
Rotation on the inner E-W axis	$40^\circ\text{S}$ .
Rotation on the N-S axis	$30^\circ\text{E}$ .

These are typical rotations to make X or Z parallel to the axis of the microscope. Rotation on outer E-W axis to optic axis position  $-60^\circ\text{N}$ . These apparent angular distances of the perpendicular from the microscope axis are corrected for refractive index on Plate I and replotted as shown.  $V$  is then read as  $57^\circ$ .

