

Copper coordination in low chalcocite and djurleite and other copper-rich sulfides

HOWARD T. EVANS, JR.

*U.S. Geological Survey
Reston, Virginia 22092*

Abstract

The new structure determinations of low chalcocite, Cu_2S , and djurleite, $\text{Cu}_{1.938}\text{S}$, have provided a large number of observations of the coordination behavior of copper with sulfur in copper-rich sulfides. Ranges of Cu-S bond lengths are 2.18 to 2.24 Å in linear CuS_2 groups; 2.21 to 2.60 Å in triangular CuS_3 groups; 2.23 to 2.90 Å in tetrahedral CuS_4 groups. Cu-Cu distances range from 2.45 Å upward, the most common around 2.77 Å. These observations are compared with structural data from other copper-rich sulfides, in which the tetrahedral, triangular and linear Cu-S bond configurations frequently show large distortions and wide variations in bond lengths.

Introduction

In nature the strategic metal copper is usually concentrated as a sulfide, or sometimes as native metal (as in the Michigan deposits). When weathering conditions are favorable, copper may be concentrated in oxide or oxysalt systems (for example, in Chile). In each of the two chemical systems—sulfide and oxide—copper behaves in a highly characteristic and distinctively different manner. The fully oxidized state (+2) in oxide systems has been continuously and intensively studied by inorganic chemists for centuries, and the behavior of copper in aqueous systems is relatively well understood. Less work has been done on anhydrous oxide (or halide) systems or on the lower valence states, and even less on sulfide systems.

The copper-sulfur system itself is very complex, and has been well defined only in the last 15 years. The phase diagram was first adequately mapped out by Roseboom (1966). The system has since been thoroughly restudied by Cook (1972) and by Potter (1977), both confirming and refining Roseboom's results. Potter used electrochemical techniques which made it possible to define both stable and metastable phase regions accurately in the low temperature ranges down to room temperature, which are not readily accessible to other methods. Earlier, Djurle (1958) used X-ray techniques to identify and define the various phases in the range Cu_2S - CuS . (No other binary compounds are known outside this range at

atmospheric pressure.) A representation of the phase diagram in the Cu_2S end of this range, adapted from Potter (1977), is shown in Figure 1.

One major ore of copper is chalcocite, Cu_2S . Its crystal structure is complex, requiring a (pseudo) orthorhombic unit cell containing 96 formula units. Rahlfs (1936) first measured this unit cell; later Buerger and Buerger (1944) made a thorough study of the orthorhombic crystallography. The existence of the close-lying phase $\text{Cu}_{1.94-1.97}\text{S}$ was not suspected until it was discovered by Djurle (1958). This phase was confirmed and established as a naturally-occurring mineral species by Roseboom (1962) and Morimoto (1962); it was appropriately named djurleite. Potter (1977) found that the homogeneity range x in Cu_xS for low chalcocite is very narrow ($x = 1.997$ to 2.000 ± 0.002), but much broader for djurleite ($x = 1.934$ to 1.965 ± 0.002). The crystallography of djurleite is even more complex than that of low chalcocite, requiring (according to Takeda, Donnay, Roseboom and Appleman, 1967) an orthorhombic unit cell containing 128 Cu_xS . Low chalcocite and djurleite are physically difficult to distinguish and probably equally common. Many samples labelled chalcocite are actually mainly djurleite, or an intimately intergrown mixture of low chalcocite and djurleite.

Because of their commercial importance low chalcocite and djurleite have been the focus of interest in the Cu-S system. Our understanding of the nature of all phases in the system will depend primarily

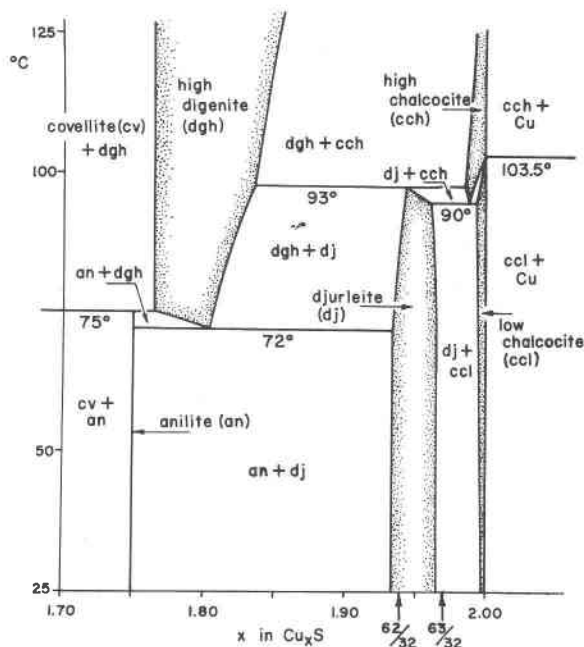

Fig. 1. Phase diagram for the system Cu-S in the low temperature region near Cu_2S adapted from Potter (1977). Single-phase regions are shaded. The crystallographic Cu/S ratios in djurleite are indicated by arrows on the abscissa.

on a knowledge of their crystal structures, and the crystal chemical behavior of copper in such systems. When the ratio of Cu to S is much below unity, copper generally is found in more or less regular tetrahedral coordination, as in chalcopyrite. When the Cu/S ratio approaches or is greater than unity, the coordination tends to decrease (as to triangular in covellite, CuS) and become irregular and more complex. The author has followed a program of study of the crystal structures of copper-rich sulfides in order to provide a broader basis for the interpretation of copper-sulfur solid state chemistry. To the present, this has included crystal structure analyses of covellite (Evans and Konnert, 1976), low chalcocite (Evans, 1971) and djurleite (Evans, 1979a). Details of the last two structures, which are published elsewhere (Evans, 1979b), have provided a rich body of information about copper in a sulfur environment. The purpose of this paper is to review this information and also that provided by other copper-rich sulfide structures. The emphasis is on coordination geometry, and no attempt is made here to discuss a theoretical basis for bonding.

Crystal structures of low chalcocite and djurleite

Low chalcocite and djurleite were originally described as orthorhombic, but both are actually mono-

clinic. Both might be considered as interstitial compounds of copper in a hexagonal-close-packed framework of sulfur. Consequently, both are subject to intensive twinning which tends to mimic the higher hexagonal symmetry. The twinning in djurleite is obvious and complex, and has been carefully studied by Takeda, Donnay, and Appleman (1967). In low chalcocite a prevalent twin law results in nearly perfect superposition of monoclinic lattices to produce an apparent end-centered orthorhombic lattice. In this structure the lower symmetry was realized only when the author discovered an untwinned X-ray intensity distribution in the single crystal patterns.

The structure analyses were carried out on data collected from untwinned crystals, using the symbolic addition procedure for phase determination. In low chalcocite, 24 Cu and 12 S atoms were found in the monoclinic asymmetric unit in space group $P2_1/c$; in djurleite, 62 Cu and 32 S were found in space group $P2_1/n$. No direct evidence of disorder was found, and all atomic sites are fully occupied. A wide variation of thermal motions became apparent in the anisotropic analyses. The sulfur and many of the copper atoms are not severely elliptical and have reasonable root-mean-square vibration amplitudes: $\sim 0.12\text{\AA}$ for S, $\sim 0.16\text{\AA}$ for Cu. Some copper atoms, especially those in ambiguous coordination, have much larger and more anisotropic vibrations. With appropriate absorption and anomalous dispersion corrections applied, in anisotropic mode, the reliability index converged for low chalcocite to $R = 0.086$ for 5,155 intensity data, and for djurleite to $R = 0.116$ for 5,686 data (Evans, 1979b).

Both structures are based on a fairly regular hexagonal-close-packed sulfur framework. The copper atoms are mainly in triangular, threefold coordination. One feature these structures have in common with certain other structures (*e.g.*, covellite, stromeyerite) is a CuS -type sheet in which the triangular network of sulfur atoms has alternate triangular sites occupied by copper atoms. This feature is prominent in high chalcocite, which has a hexagonal unit cell containing 2 Cu_2S , but according to Clava, Reidinger, and Wuensch (1979) these sites are only 71 percent occupied. Similar sheets are present in low chalcocite and djurleite, but the continuous CuS net is interrupted in an ordered manner by many vacant triangular sites. Figure 2 shows schematic views of the unit cells of low chalcocite and djurleite viewed along the monoclinic b axes, to illustrate the distribution of copper atoms with respect to these sheets,

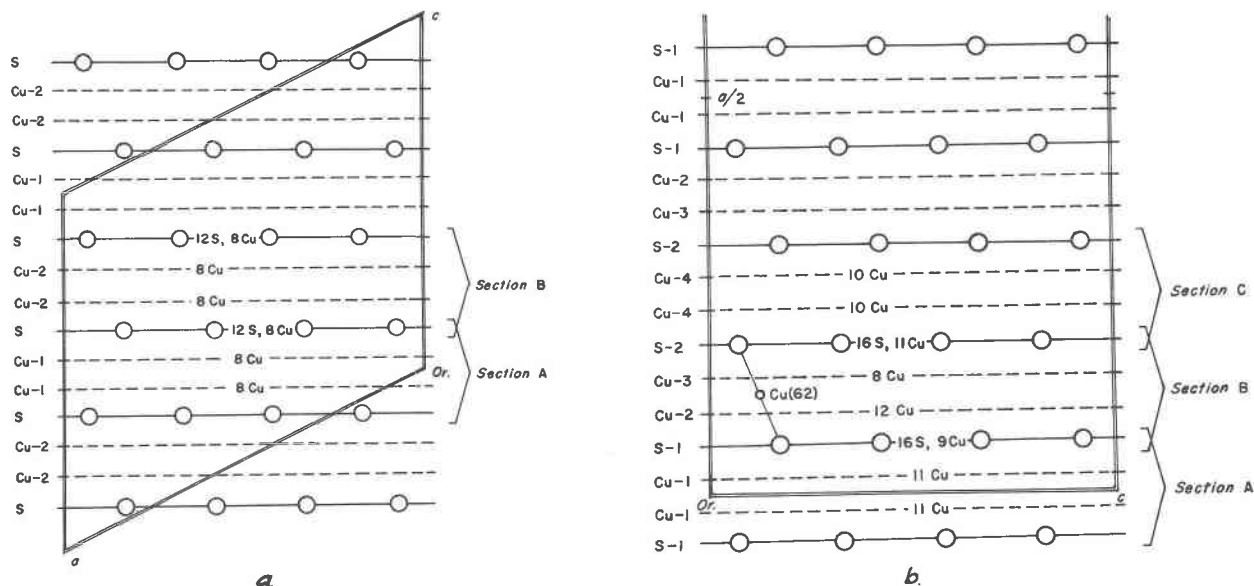

Fig. 2. Schematic projections of the crystal structures of (a) low chalcocite and (b) djurleite projected along the monoclinic b axes. The hexagonal-close-packed layers of sulfur atoms (circles) are shown on edge in these views and the distribution of the copper atoms (not shown) is indicated.

which appear on edge in these views. In low chalcocite there is one kind of sheet, S-1, containing within the cell 12 S atoms and 8 Cu atoms; in djurleite there are two kinds of sheets, S-1 and S-2, each containing 16 S atoms, but with 9 Cu in S-1 and 11 Cu in S-2. The remaining copper atoms lie at approximately $\frac{1}{3}$ and $\frac{2}{3}$ positions between the sheets (except Cu(62) of djurleite, which is halfway between). Figure 2 shows the copper distribution in these different sheets.

In Figure 3 stereoscopic views of portions of the crystal structure of low chalcocite are shown viewed along the c axis in sections as indicated in Figure 2; in Figure 4 similar views of djurleite are shown. These views illustrate the ellipsoids of thermal vibration as 50 percent probability envelopes, and also the numbering system of the atoms as used by Evans (1979b). In Figure 3, the top layer of sulfur atoms in section A is identical with the bottom layer in section B; the bottom layer of section A is the same as the top layer of section B, but inverted by glide symmetry. Figure 4 shows similar stereoscopic projections of djurleite in 3 sections viewed along the a axis. In Figure 4 the top sulfur layers in section A and section B are identical with the bottom layers of section B and section C respectively, but the top layer of section A is the same as the bottom layer of the same section, related by symmetry centers; the top layer of section C is the same as the bottom of this section, related by glides and centers. New ways are still being sought to illustrate these complex structures.

Bond distributions in low chalcocite and djurleite

In the structures of low chalcocite and djurleite the Cu-S bond lengths are between 2.18 and 2.90 Å (somewhat arbitrarily ignoring Cu-S distances greater than 2.90 Å), although most, especially those clearly associated with triangular coordination, are less than 2.50 Å. Among the triangles some have nearly equal Cu-S distances of 2.31 ± 0.01 Å (e.g., Cu(2), Cu(9), Cu(13) of low chalcocite; Cu(7), Cu(25), Cu(38) of djurleite), but these have S-Cu-S angles ranging from 111.8° to 131.6°. The most severely distorted coordination in low chalcocite is shown by Cu(15) and Cu(19), which both have two short (2.18 to 2.24 Å) and one long distance (2.87 and 2.91 Å), suggesting an approach to linear, twofold coordination; and Cu(14) (four bonds 2.25 to 2.87 Å) which is grossly displaced from the nearest triangular plane. In djurleite, one copper atom, Cu(62), unambiguously has twofold coordination (2.18 and 2.19 Å, S-Cu-S angle 172.2°), whereas 11 others are notably displaced from triangular planes, approaching tetrahedral coordination. In Figure 5, the distribution of Cu-S bond lengths for all the copper atoms in these two structures is shown as dashes joined by a bar for each atom. The wide variation in the averages for each CuS_3 or CuS_4 configuration is striking, but a line can be drawn through all the bars at 2.30 ± 0.01 Å. The S-Cu-S angles for these have not been shown, but they range from 97.6° to 150.6°.

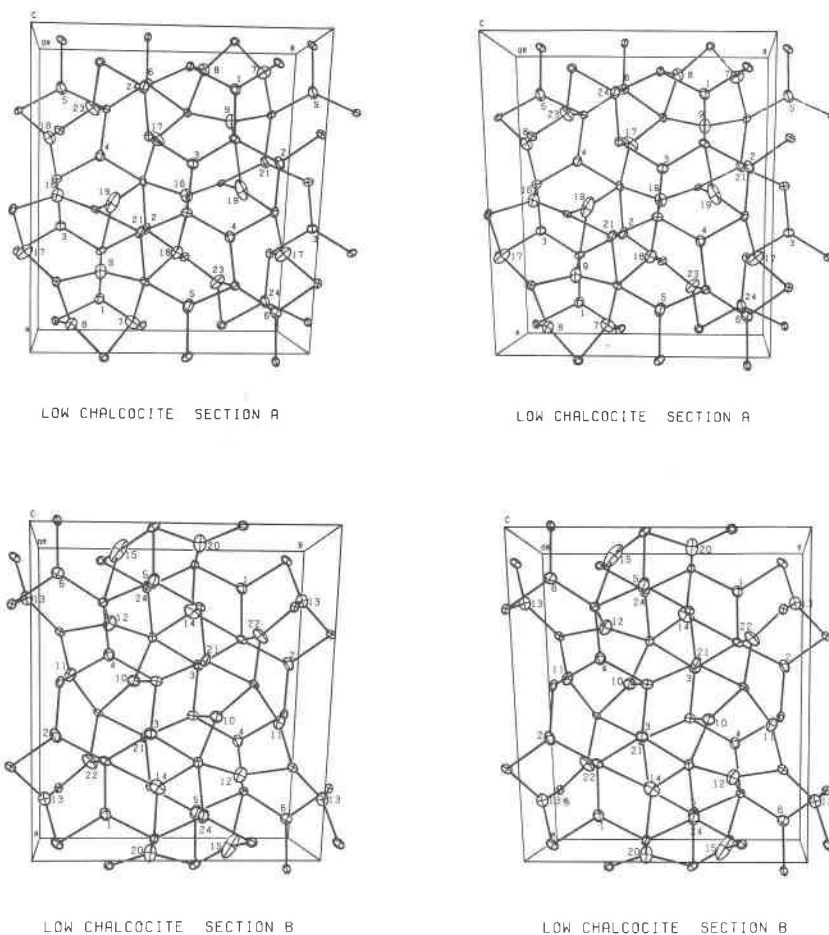

Fig. 3. Stereoscopic projections of the crystal structure of low chalcocite viewed along the *c* axis, normal to the sulfur layers. The atoms are represented as 50 percent probability thermal ellipsoids, and only the Cu atoms are numbered. The structure is shown in two sections as indicated in Figure 2a.

A major influence on the actual location of a given copper atom is imposed by other surrounding copper atoms. Each copper atom is surrounded by 2 to 7 other copper atoms at distances less than 3.0\AA . The nearest approach is 2.52\AA in low chalcocite and 2.45\AA in djurleite (the Cu–Cu distance in metallic copper is 2.556\AA). All of these Cu–Cu distances are shown for each copper atom as circles in Figure 5.

All of the 270 Cu–S interatomic distances less than 3.0\AA in low chalcocite and djurleite are collected to produce the population histogram in Figure 6a, where the lengths are counted in intervals of 0.05\AA . A symmetrical peak is formed centered at 2.30\AA , which represents the average triangular bond length in these structures. A corresponding diagram for 403 Cu–Cu distances (Fig. 6b) shows a peak at about 2.77\AA , which corresponds to the nearest available neighboring triangular site to a given triangular site in the close-packed sulfur framework.

The hexagonal-close-packed sulfur framework itself is somewhat but not severely distorted. The S–S distances range from 3.9 to 4.2\AA , giving an average of 3.95\AA . As an indicator of the amount of distortion in the framework, the largest displacement of sulfur from the mean plane of the sulfur sheets is 0.18\AA , and the average displacement is 0.09\AA . Of the 44 different sulfur atoms 32 are bonded to 6 copper atoms, 11 to 7, and 1 to 5, in a fairly even distribution in space.

The composition range measured by Potter (1977) for djurleite closely matches the span $x = 62/32$ to $63/32$ in Cu_xS (see Fig. 1). The author's structure analysis of djurleite from Sweetwater, Missouri (Evans, 1979b) revealed only 62 copper atoms in the asymmetric unit, indicating a composition for that crystal at the lower limit of the indicated range. The possibility exists, therefore, that a site is available in the crystal structure into which one additional copper

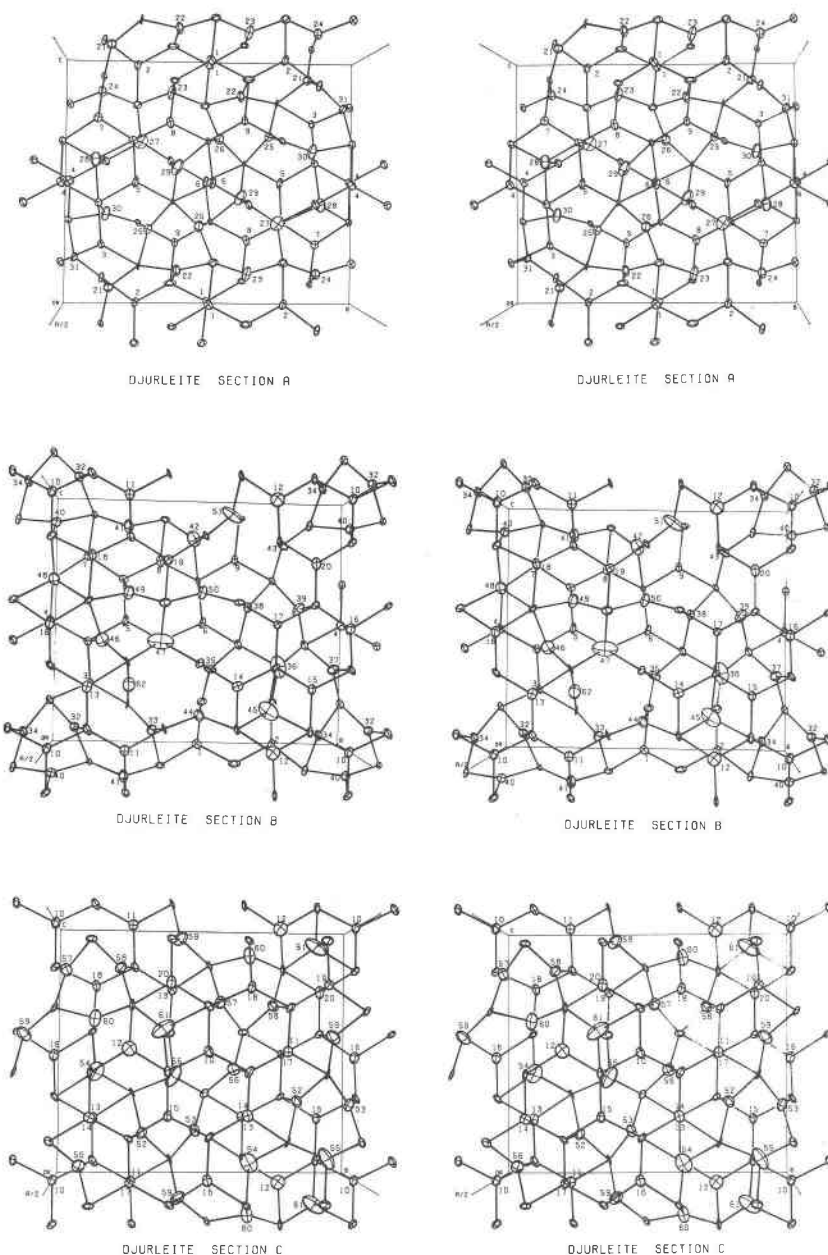

Fig. 4. Stereoscopic projections of the crystal structure of djurleite viewed along the a axis normal to the sulfur layers, in three sections as indicated in Fig. 2b. Details are shown as in Figure 3.

atom can be inserted without seriously disturbing the structure. A careful search for such a site showed that no triangular or linear sites are available, but that there are three or four possible tetrahedral sites. No trace of any electron density was found at these sites in the structure analysis. Unfortunately, no firm prediction can be made as to the location of a 63rd Cu atom, and a new crystal structure analysis on a phase in equilibrium with low chalcocite will be needed to find this atom. Such a structure analysis is not contemplated by the author at this time.

Special features of the structures of low chalcocite and djurleite

The most unexpected feature to appear in these structures is the linear, twofold CuS_2 group in djurleite (seen as Cu(62) in the lower left region of Section B of Fig. 4). Only rarely has such a group been reported for copper in a copper sulfide solid phase; one is found in the structure of synthetic $\text{Bi}_2\text{Cu}_3\text{S}_4\text{Cl}$ described by Lewis and Kupcik (1974), and in that compound it is in disorder with a triangular group.

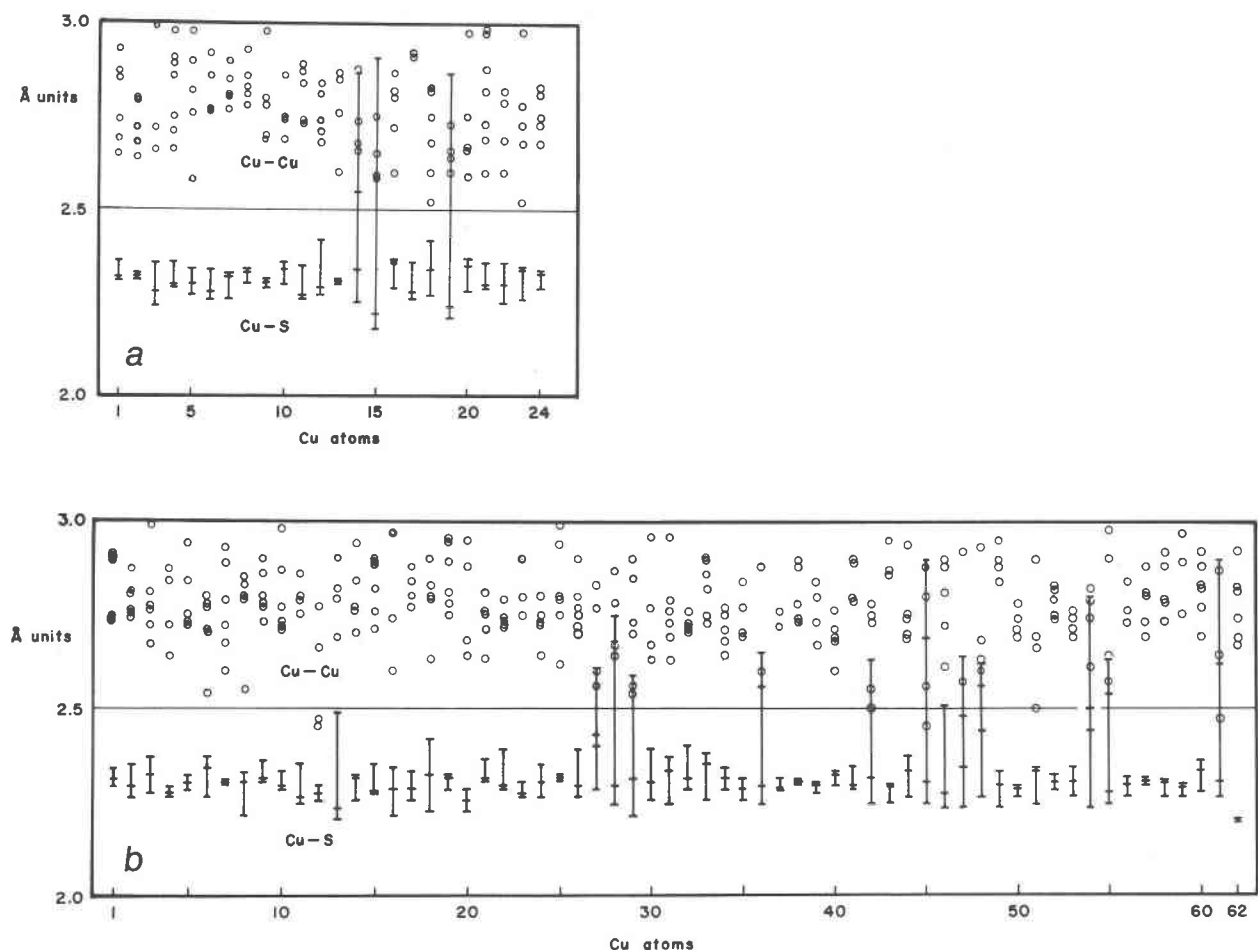

Fig. 5. Copper-sulfur bond lengths (marked on vertical bars) and copper-copper distances (open circles) plotted for the 24 different copper atoms in low chalcocite (a) and 62 copper atoms in djurleite (b).

Two copper atoms in low chalcocite show a strong tendency for linear coordination, each having two short bonds at an angle of 150° . These atoms, Cu(15) and Cu(19), show exaggerated elongation of their thermal ellipsoids, indicating a disorder between triangular and linear sites here also, but it was not possible to prove this hypothesis conclusively in the structure analysis (Evans, 1979b).

An octahedron of sulfur atoms may be considered as an integral element (never isolated) of the structures of low chalcocite and djurleite. The dimensions of the ideal configuration, shown in Figure 7, will be: edge (S-S distance) 3.95\AA ; Cu-S (triangle), 2.28\AA ; Cu-S (linear), 1.98\AA ; Cu-Cu (adjacent triangles) 1.86\AA ; Cu-Cu (alternate triangles), 2.63\AA ; Cu-Cu (opposite triangles), 3.23\AA . The CuS_3 triangle is of nearly optimum size in the sulfur framework, but the introduction of a linear CuS_2 group requires a con-

siderable local distortion of the framework. Appreciable local adjustments are also needed to allow the Cu-Cu distances to adopt longer distances around 2.8\AA . In the two structures, pairs of triangular groups that share an edge (two sulfur atoms) are rare. Where such a configuration might occur, one of the copper atoms is generally forced out of the triangle toward a tetrahedral center, or toward a linear position as with Cu(15) and Cu(19) in low chalcocite. Such atoms always have large and markedly anisotropic apparent thermal motions. In djurleite there is one edge-shared pair of fairly normal triangles adjacent to the symmetry center at $0, 1/2, 1/2$. Here the adjacent (edge-shared) Cu-Cu distance is 2.54\AA , the alternate (corner-shared) distance is 2.70\AA and the opposite distances (through the symmetry center) are 3.47 and 3.94\AA .

Certainly, low chalcocite and djurleite are very

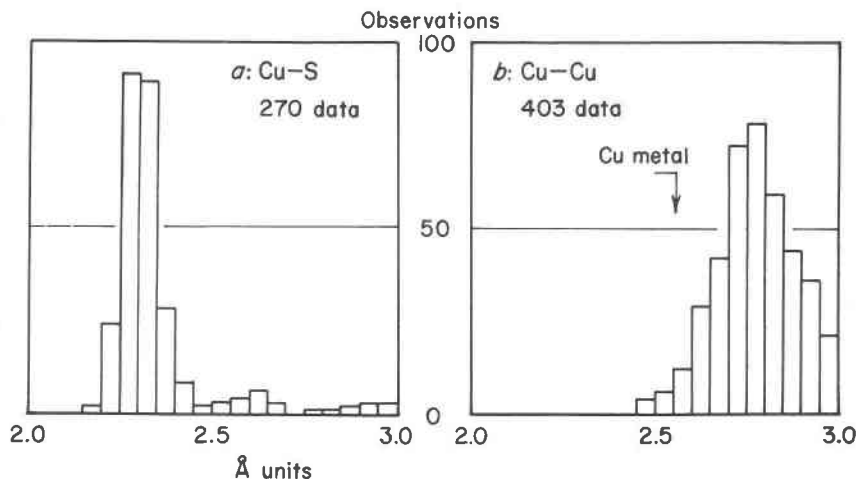

Fig. 6. Distribution of copper-sulfur bond lengths (a) and copper-copper distances (b) in low chalcocite and djurleite combined.

crowded structures, in which the Cu-Cu distances average little more than those in the metal. Presumably some sort of metal-metal interaction is involved in these structures, although they are in fact p-type semiconductors (Shuey, 1975). At 103°C for low chalcocite and 93° for djurleite the copper portion of these structures effectively melts while the sulfur portion remains intact in the hexagonal high-chalcocite phase. A heating experiment with the Guinier-Lenne heating X-ray powder camera showed no perceptible change in unit cell volume of low chalcocite up to the transition point. At this point the volume expansion of the subcell to the hexagonal high chalcocite unit cell is only 0.7 percent. The appearance of high ionic conductivity in high chalcocite (Hirahara, 1951) is associated with the tenuous and extended electron density in the sulfur interstices found by Buerger and Wuensch (1963) and Sadanaga, *et al.* (1965). The

three phases differ only slightly in their free energy content, and the high mobility of the copper atoms permits the rapid and easy transformation of one phase into another (Putnis, 1977).

Comparison with other copper-rich sulfides

The trend toward decreasing copper coordination with increasing Cu/S ratio is well established. Most copper compounds in which Cu/S ratio is less than 0.5 contain copper in fairly regular tetrahedral coordination: for example, chalcopyrite, CuFeS_2 (Cu-S distance 2.302Å; Hall and Stewart, 1973). As the ratio passes unity to higher values, triangular coordination becomes more and more prevalent, until in low chalcocite and djurleite, it predominates. Finally, linear twofold coordination occasionally appears. Figure 8 shows some of the species in the Cu/S range of approximately 1 to 2, and shows the variation of Cu-S bond lengths in these species. Figures 9 to 12 illustrate the copper coordination in four of these structures.

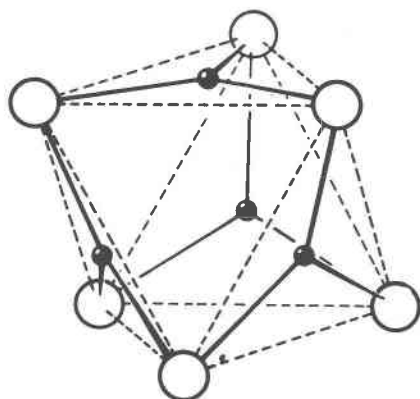

Fig. 7. Idealized octahedron of sulfur atoms (open circles), with 4 copper atoms occupying alternate faces.

Triangular coordination for copper was first found by Oftedal (1932) in the structure of covellite, which has recently been refined (Evans and Konnert, 1976; Kalbskopf, Pertlik and Zeemann, 1975). Of the six copper atoms in the hexagonal unit cell, two are in slightly distorted tetrahedral coordination (apical Cu-S, 2.331Å, basal 2.305Å) and four are in regular triangular coordination (2.191Å). The tetrahedron is typical, comparable with that in chalcopyrite, but the triangular bond length is unusually short (see Figs. 8 and 9). According to Shuey (1975) covellite is a p-type metal, and from X-ray photoelectron spectroscopic studies, while Nakai *et al.* (1978) have shown

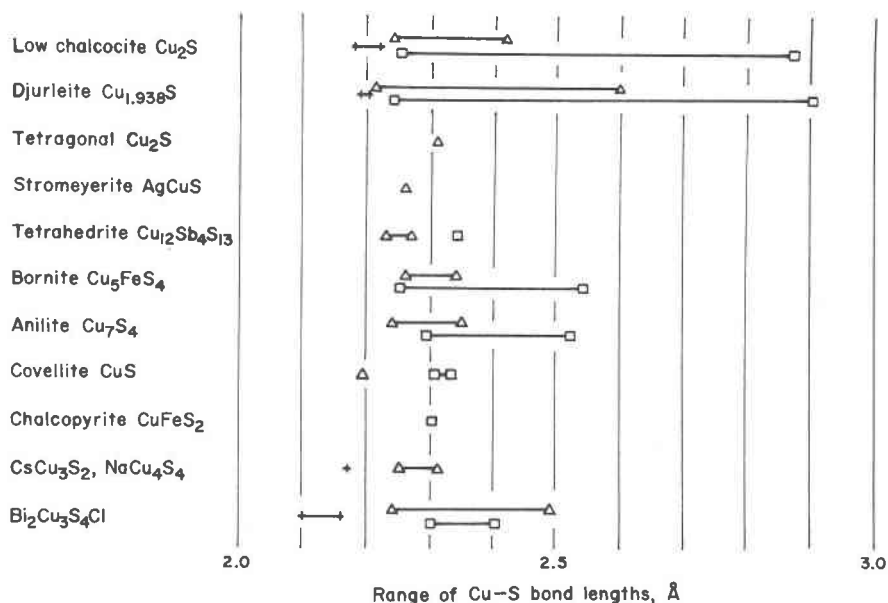

Fig. 8. Ranges of copper-sulfur bond lengths in various copper-rich sulfide structures, in linear CuS_2 groups (crosses); in triangular CuS_3 groups (triangles); in tetrahedral CuS_4 groups (squares).

that copper is monovalent in most sulfides, including covellite. From X-ray photoelectron spectroscopic studies Folmer and Jellinek (1980) have concluded that the conducting electrons in covellite are drawn from the sulfur atoms, and that the shortened tri-

angular Cu-S bonds result from the reduced size of the associated S^- ions.

Another earlier report of triangular coordination is in stromeyerite, AgCuS (Frueh, 1955). Here the triangular sheet is the same as that found in covellite, and in interrupted form in low chalcocite and djurleite. All of the copper is confined to these sheets, which are joined to each other through linear S-Ag-S links (Fig 10). The Ag-S distance is 2.40\AA , whereas

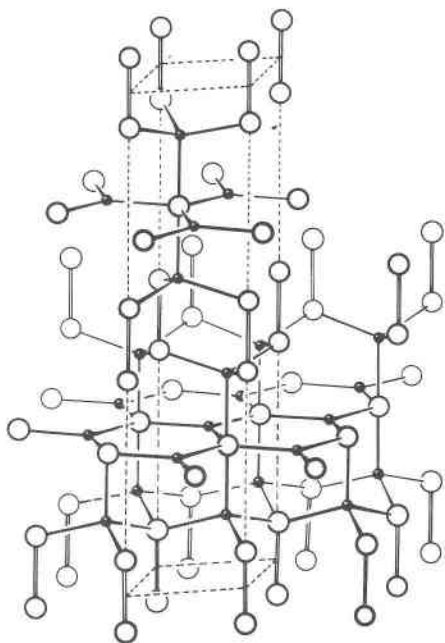

Fig. 9. The crystal structure of covellite. Large open circles are sulfur atoms, small black circles are copper atoms in this and following figures.

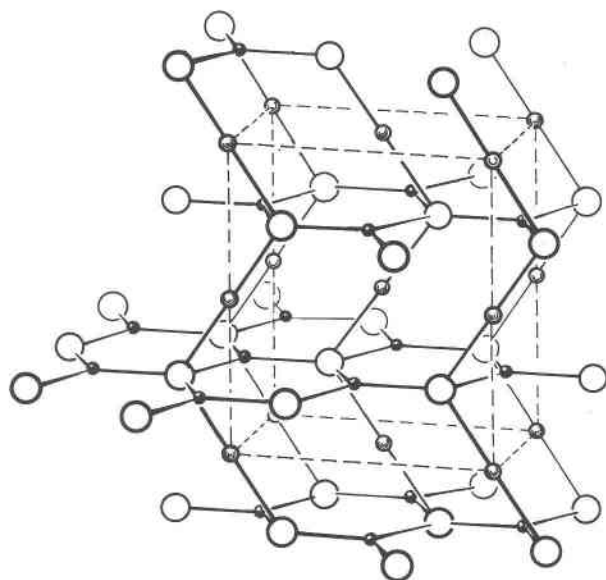

Fig. 10. The crystal structure of stromeyerite. Medium-sized circles (line shaded) are silver atoms.

the known linear Cu-S distances are not greater than 2.20Å. Thus in stromeyerites that are slightly deficient in silver, it is not likely that copper will enter this site in its place.

Recently, Cava *et al.* (1979), using neutron diffraction data, have successfully refined the highly disordered structure of high chalcocite at four different temperatures, 120°, 200°, 260° and 325°C, by assuming anharmonic thermal motion for the copper atoms. They found that by distributing Cu in two different sites, all of the copper could be accounted for and a reliability index of $R = 0.071$ was attained (at 120°C). The alternate triangular sites in the hexagonal close-packed sulfur layers are 71 percent occupied in regular coordination. In addition, all (12) of the triangular sites between the layers are populated by the remaining Cu atoms, each site occupied 21 percent of the time. The latter have highly extended and anharmonic electron-density distributions, but clearly in the disordered, high temperature state, copper is found mainly in triangular coordination.

Anilite, Cu_7S_8 , is a recently described low-temperature phase in the Cu-S sulfur system, which has a unique structure reported by Koto and Morimoto (1970). Of 28 copper atoms in the orthorhombic unit cell, 8 are in tetrahedral coordination and 20 are in triangular coordination (Fig. 11). As the cation population becomes more crowded, these configurations exhibit more distortion than is found in covellite or stromeyerite. The Cu-S bonds in the tetrahedra

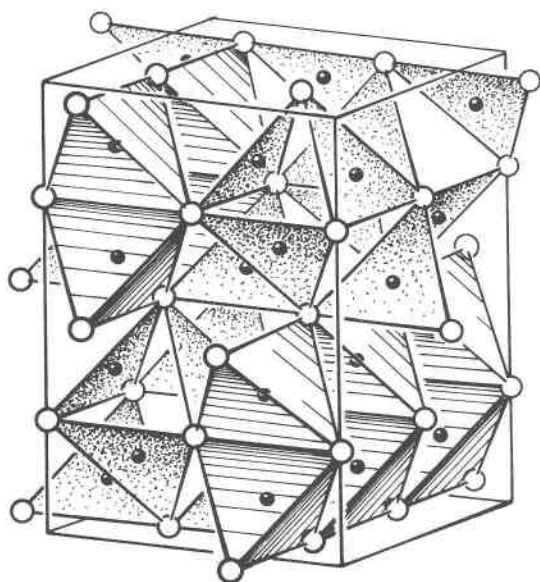

Fig. 11. The crystal structure of anilite. CuS_3 and CuS_4 coordination groups are shown as triangles and tetrahedra.

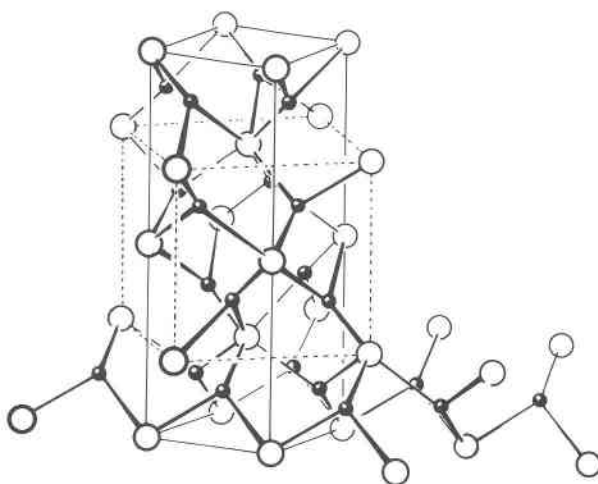

Fig. 12. The crystal structure of tetragonal (high pressure) Cu_2S . The cubic unit of the close-packed sulfur framework is indicated by dashed lines.

range from 2.29 to 2.52Å, and the S-Cu-S angles from 102° to 135°; in the triangles the respective ranges are 2.24 to 2.35Å and 109° to 133°. Cu-Cu distances as low as 2.64Å are found, and the average copper atom has 4 copper neighbors at distances less than 3.0Å, compared with 4.7 neighbors for low chalcocite and djurleite. For comparison, the nearest Cu-Cu distance in covellite is 3.199Å.

The structure of the tetragonal, high-pressure form of Cu_2S (Janosi, 1964) is interesting in its simplicity; it contains only one kind of copper atom in a regular triangle with Cu-S bond length 2.31Å, and S-Cu-S angle 120°. (Fig. 12). This form is stable above about 2 kbars, and has a specific cell volume about 1.3 percent smaller than that of low chalcocite. Cu-Cu distances are all greater than 2.64Å. The reason why this seemingly simple and satisfactory structure should revert to the very complex low-chalcocite structure at atmospheric pressure is at present wholly unknown.

The structure of bornite, Cu_5FeS_4 , is usually obscured by intense pseudocubic twinning, but Koto and Morimoto (1975) have evolved details of an orthorhombic superstructure in which the cations are divided into two groups, one tetrahedral and the other triangular in coordination. The structure of tetrahedrite, $\text{Cu}_{12}\text{Sb}_4\text{S}_{13}$, (Wuensch, 1964) also contains both triangular and tetrahedral groups.

As mentioned above, in all sulfide structures known at present having $\text{Cu/S} < 0.5$, the copper is in tetrahedral coordination. This coordination can be seen also in structures that have a high Cu/S ratio,

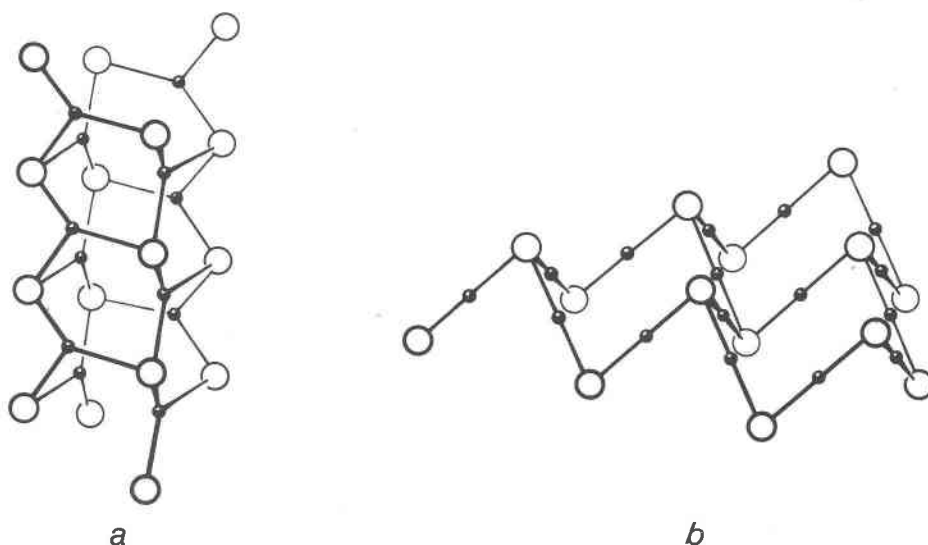

Fig. 13. Structures of (a) the $(\text{Cu}_4\text{S}_4)_n^{2-}$ chain in $\text{Na}_3\text{Cu}_4\text{S}_4$, and (b) the $(\text{Cu}_3\text{S}_2)_n^{2-}$ sheet in CsCu_3S_2 .

but always in highly distorted form. In fact, in the clearly triangular groups, the Cu atom is often more or less displaced out of the triangular S_3 plane, and is sometimes described as approaching tetrahedral coordination. This configuration in which three Cu-S bonds are short (~ 2.25 – 2.4\AA) and one is long (2.4 – 2.9\AA) seems to be characteristic for copper in sulfides, and can be seen even in structures that have a low Cu/S ratio. For example, in aikinite, PbCuBiS_3 (Kohatsu and Wuensch, 1971), the Cu-S distances in the tetrahedron are 2.31, 2.37, 2.37, and $2.43 (\pm$

$0.001)\text{\AA}$; in gladite, $\text{PbCuBi}_5\text{S}_9$ (Kohatsu and Wuensch, 1976) they are 2.29, 2.34, 2.34, and $2.55 (\pm 0.03)\text{\AA}$. On the whole, however, it is difficult to find any systematic tendencies in the wide variations in copper coordination in sulfides. Nevertheless, the tetrahedral coordination is quite regular in some structures, such as chalcopyrite, CuFeS_2 (Hall and Stewart, 1973); covellite $\text{Cu}_3\text{S}(\text{S}_2)$ (Evans and Konnert, 1976); and tetrahedrite, $\text{Cu}_{12}\text{Sb}_4\text{S}_{13}$ (Wuensch, 1964), in all of which the Cu-S bond lengths are within the range 2.30 – 2.34\AA .

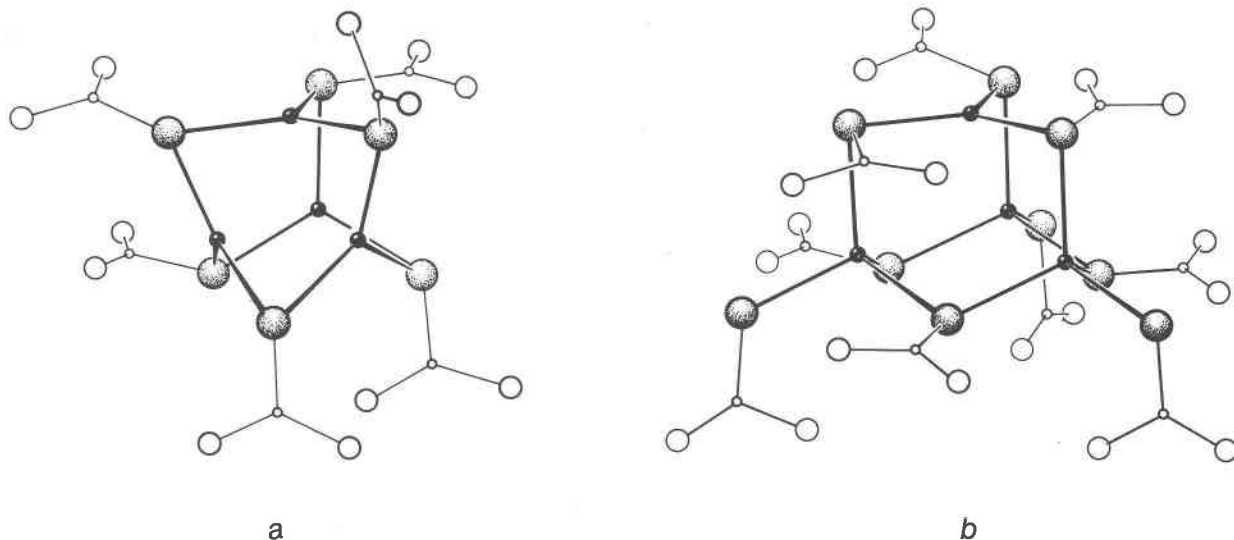

Fig. 14. Molecular structures of the thiourea-copper complexes (a) $[\text{Cu}_4(\text{SCN}_2\text{H}_4)_6]^{4+}$, (b) $[\text{Cu}_4(\text{SCN}_2\text{H}_4)_9]^{4+}$.

A rich group of synthetic alkali copper sulfides has long been known, and has been recently investigated in terms of their crystal chemistry. In $\text{Na}_3\text{Cu}_4\text{S}_4$ isolated tubelike chains are made up of CuS_3 triangles (Burschka, 1980). These chains may condense laterally to form layer structures as found in KCu_3S_2 and $\text{K}_3\text{Cu}_8\text{S}_6$, the latter also incorporating copper in tetrahedral coordination (Burschka, 1979). Similar complex layers have also been found in BaCu_4S_3 by Iglesias and Steinfink (1975). In CsCu_3S_2 two layers of sulfur in close packing are joined by copper atoms in linear, twofold coordination (Burschka, 1980). The chain and sheet motifs are shown in Figure 13. In the triangles the Cu–S distance averages 2.30\AA , and the linear Cu–S distance is 2.17\AA . In all these compounds many Cu–Cu distances lie in the range $2.55\text{--}2.75\text{\AA}$.

Organometallic cluster model complexes

The octahedral group in which the octahedron has all four alternate octahedral faces occupied occurs twice in low chalcocite [$\text{Cu}(1,7,8,9)$, $\text{Cu}(4,10,11,12)$] and twice in djurleite [$\text{Cu}(7,22,25,26)$, $\text{Cu}(18,57,58,60)$]. It is not suggested that the presence of these Cu_4S_6 groups imparts any molecular character to the copper sulfide structures. Nevertheless, it is interesting to find several organometallic monovalent copper complexes that have been synthesized and

shown to contain this same configuration. One example is the thiourea (NH_2CSNH_2 , tu) complex $[\text{Cu}_4\text{tu}_6](\text{NO}_3)_4 \cdot 4\text{H}_2\text{O}$ (Griffith *et al.*, 1976). The molecular cation is shown in Figure 14a. The group is somewhat distorted in terms of bond lengths (2.19 to 2.31\AA), S–Cu–S angles (106° to 126°) and warping of the triangular planes. Cu–Cu distances vary from 2.83 to 3.09\AA . These authors also report that when the concentration of thiourea in the acidic aqueous solutions is increased, the complex adds on three more thiourea molecules by converting three of the CuS_3 triangles to tetrahedra, to form $[\text{Cu}_4\text{tu}_9](\text{NO}_3)_4 \cdot 4\text{H}_2\text{O}$ (Fig. 14b). In the new compound the remaining triangle is regular with a Cu–S bond length of 2.24\AA .

Other monovalent copper complexes that have been reported are of interest in that they contain linear CuS_2 groups. Dance (1976a) has prepared from ethanol solutions a thiophenol ($\text{C}_6\text{H}_5\text{SH}$) complex of composition $[(n\text{-C}_4\text{H}_9)_4\text{N}]_2[\text{Cu}_5(\text{SC}_6\text{H}_5)_7]$ in which the pentanuclear copper anion cluster contains four triangular CuS_3 groups and one linear CuS_2 group, as shown in Figure 15a. The molecule may be derived from the octahedral Cu_4S_6 complex by replacing one S atom by a linear S–Cu–S link. The triangular Cu–S bond lengths average 2.27\AA and the linear bond lengths are 2.16\AA . From similar systems Dance (1976b) has also prepared the compound $[(\text{C}_2\text{H}_5)_4\text{N}]$

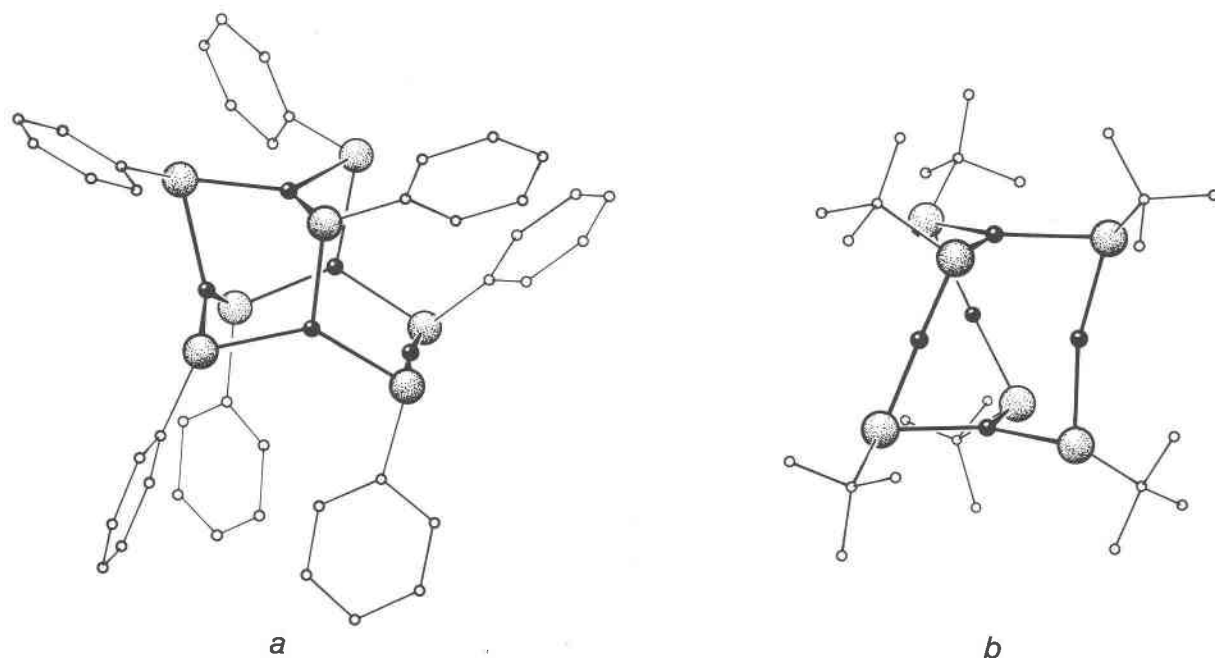

Fig. 15. Molecular structures of the thiol-copper complexes (a) $[\text{Cu}_5(\text{SC}_6\text{H}_5)_7]^{2-}$, and (b) $[\text{Cu}_5(\text{SC}_4\text{H}_9)_6]^-$.

[Cu₅(S-t-C₄H₉)₆], which has a pentanuclear cluster containing two triangular groups and three linear groups (Fig. 15b). Here the triangular Cu-S bond length is 2.27Å and the linear bond length is 2.17Å. In this molecule, which has D₃ symmetry, the three linear S-Cu-S groups are bent inward to 170° and thus three copper atoms appear to be somewhat attracted to the capping triangular atoms, which are at a distance of 2.72Å. This phenomenon supports the suggestion that copper atoms positively interact in the sulfur environment.

Perhaps by studying model Cu-S clusters of this type, further insight can be gained into the behavior of copper in the copper-rich sulfides.

References

- Buerger, M. J. and Buerger, N. W. (1944) Low chalcocite and high chalcocite. *American Mineralogist*, 29, 55-65.
- Buerger, M. J. and Wuensch, B. J., (1963) Distribution of atoms in high chalcocite, Cu₂S. *Science*, 141, 276-277.
- Burschka, C. (1979) Na₃Cu₄S₄-ein Thiocuprate mit imverknüpften [Cu₄S₄]-Ketten. *Zeitschrift für Naturforschung*, 34b, 396-397.
- Burschka, C. (1980) CsCu₄S₃ und CsCu₃S₂: Sulfide mit tetraedrische und linear koordinierten Kupfer. *Zeitschrift für anorganische und allgemeine Chemie*, 463, 65-71.
- Cava, R. J., Reidinger, F. and Wuensch, B. J. (1979) A single-crystal neutron-diffraction study of the mobile Cu ions in the fast-ion conductor β-Cu₂S (high chalcocite). *American Crystallographic Association Program and Abstracts*, vol. 6, no. 2, 87.
- Cook, W. R., Jr. (1972) Phase changes in Cu₂S as a function of temperature. *National Bureau of Standards Special Publication 364, Solid State Chemistry*, 703-711.
- Dance, I. G. (1976a) Formation and x-ray structure of the hexa-(t-butylthiolato) pentacuprate (I) monoanion. *Chemical Communications*, 1976, 68-69.
- Dance, I. G. (1976b) The hepta (μ₂-benzenethiolato)-pentacuprate (I) dianion; x-ray crystal and molecular structure. *Chemical Communications*, 1976, 103-104.
- Djurle, S. (1958) An x-ray study on the system Cu-S. *Acta Chemica Scandinavica*, 12, 1415-1426.
- Evans, H. T., Jr (1971) Crystal structure of low chalcocite. *Nature Physical Science*, 232, 69-70.
- Evans, H. T., Jr. (1979a) Djurleite (Cu_{1.94}S) and low chalcocite (Cu₂S): new crystal structure studies. *Science*, 203, 356-358.
- Evans, H. T., Jr. (1979b) The crystal structures of low chalcocite and djurleite. *Zeitschrift für Kristallographie*, 150, 299-320.
- Evans, H. T., Jr. and Konnert, J. A. (1976) Crystal structure refinement of covellite. *American Mineralogist* 61, 996-1000.
- Folmer, J. C. W. and Jellinek, F. (1980) The valence of copper in sulfides and selenides: an x-ray photoelectron spectroscopy study. *Journal of the Less Common Metals*, 76, 153-162.
- Frueh, A. J., Jr. (1955) The crystal structure of stromeyerite, AgCuS: a possible defect structure. *Zeitschrift für Kristallographie*, 106, 299-301.
- Griffith, E. H., Hunt, G. W., and Amma, E. L. (1976) The adamantane structure in polynuclear Cu₄S₆ cores: The crystal and molecular structures of Cu₄[SC(NH₂)₂]₆(NO₃)₄ · 4H₂O and Cu₄[SC(NH₂)₂]₉(NO₃)₄ · 4H₂O. *Chemical Communications*, 1976, 432-433.
- Hall, S. R. and Stewart, J. M. (1973) The crystal structure refinement of chalcopyrite, CuFeS₂. *Acta Crystallographica*, B29, 579-585.
- Hirahara, E. (1951) The electrical conductivity and isothermal Hall effect in cuprous sulfide semiconductor. *Journal of the Physical Society of Japan*, 6, 428-437.
- Iglesias, J. E. and Steinfink, H. (1975) The crystal structures and phase transition of α and β BaCu₄S₃. *Materials Research Bulletin* 7, 1247-1258.
- Janosi, A. (1964) La structure du sulfure cuivreux quadratique. *Acta Crystallographica*, 17, 311-312.
- Kalbskopf, R., Pertlik, F., and Zeemann, J. (1975) Verfeinerung der Kristallstruktur des Covellins, CuS, mit Einkristalldaten. *Tschermak's Mineralogische und Petrologische Mitteilungen*, 22, 242-249.
- Kohatsu, I. and Wuensch, B. J. (1971) The crystal structure of aikinite, PbCuBiS₃. *Acta Crystallographica*, B27, 1245-1252.
- Kohatsu, I. and Wuensch, B. J. (1976) The crystal structure of glaudite PbCuBi₅S₉, a superstructure intermediate in the series Bi₂S₃-PbCuBiS₃ (bismuthinite-aikinite). *Acta Crystallographica*, B32, 2401-2409.
- Koto, K. and Morimoto, N. (1970) The crystal structure of anilite. *Acta Crystallographica*, B26, 915-924.
- Koto, K. and Morimoto, N. (1975) Superstructure investigation of bornite, Cu₅FeS₄, by the modified partial Patterson function. *Acta Crystallographica*, B31, 2268-2273.
- Lewis, J., Jr. and Kupcik, V. (1974) The crystal structure of Bi₂Cu₃S₄Cl. *Acta Crystallographica*, B30, 848-852.
- Morimoto, N. (1962) Djurleite, a new copper sulfide mineral. *Mineralogical Journal (Tokyo)*, 3, 338-344.
- Nakai, I., Sugitani, Y., Nagashima, K. and Niwa, Y. (1978) X-ray photoelectron spectroscopic study of copper minerals. *Journal of Inorganic and Nuclear Chemistry*, 40, 789-791.
- Oftedal, I. (1932) The crystal structure of covellite. *Zeitschrift für Kristallographie*, 83, 9-25.
- Potter, R. W. II (1977) An electrochemical investigation of the system copper-sulfur. *Economic Geology*, 72, 1524-1542.
- Putnis, A. (1977) Electron diffraction study of phase transformations in copper sulfides. *American Mineralogist*, 62, 107-114.
- Rahlf's, P. (1936) Über die kubischen Hochtemperaturmodifikationen der Sulfide, Selenide und Telluride des Silbers und des einwertigen Kupfers. *Zeitschrift für Physikalische Chemie*, B31, 157-194.
- Roseboom, E. H., Jr. (1962) Djurleite, Cu_{1.96}S, a new mineral. *American Mineralogist* 47, 1181-1184.
- Roseboom, E. H., Jr. (1966) An investigation of the system Cu-S and some natural copper sulfides between 25° and 700°C. *Economic Geology*, 61, 641-672.
- Sadanaga, R., Ohmasa, M., and Morimoto, N. (1965) On the statistical distribution of copper ions in the structure of β-chalcocite. *Mineralogical Journal (Tokyo)*, 4, 275-290.
- Shuey, R. T. (1975) *Semiconducting ore minerals*. Elsevier Scientific Publishing Co., New York.
- Takeda, H., Donnay, J. D. H. and Appleman, D. E. (1967) Djurleite twinning. *Zeitschrift für Kristallographie*, 125, 414-422.
- Takeda, H., Donnay, J. D. H., Roseboom, E. H., and Appleman, D. E. (1967) The crystallography of djurleite, Cu_{1.97}S. *Zeitschrift für Kristallographie*, 125, 404-413.
- Wuensch, B. J. (1964) The crystal structure of tetrahedrite, Cu₁₂Sb₄S₁₃. *Zeitschrift für Kristallographie*, 119, 437-453.